

GUHRING

EFFICIENCY IN PERFECTION



MULTI-FUNCTIONAL TOOLING SYSTEMS
FOR END MACHINING

Optimal combination of all tool parameters with our own R&D operations

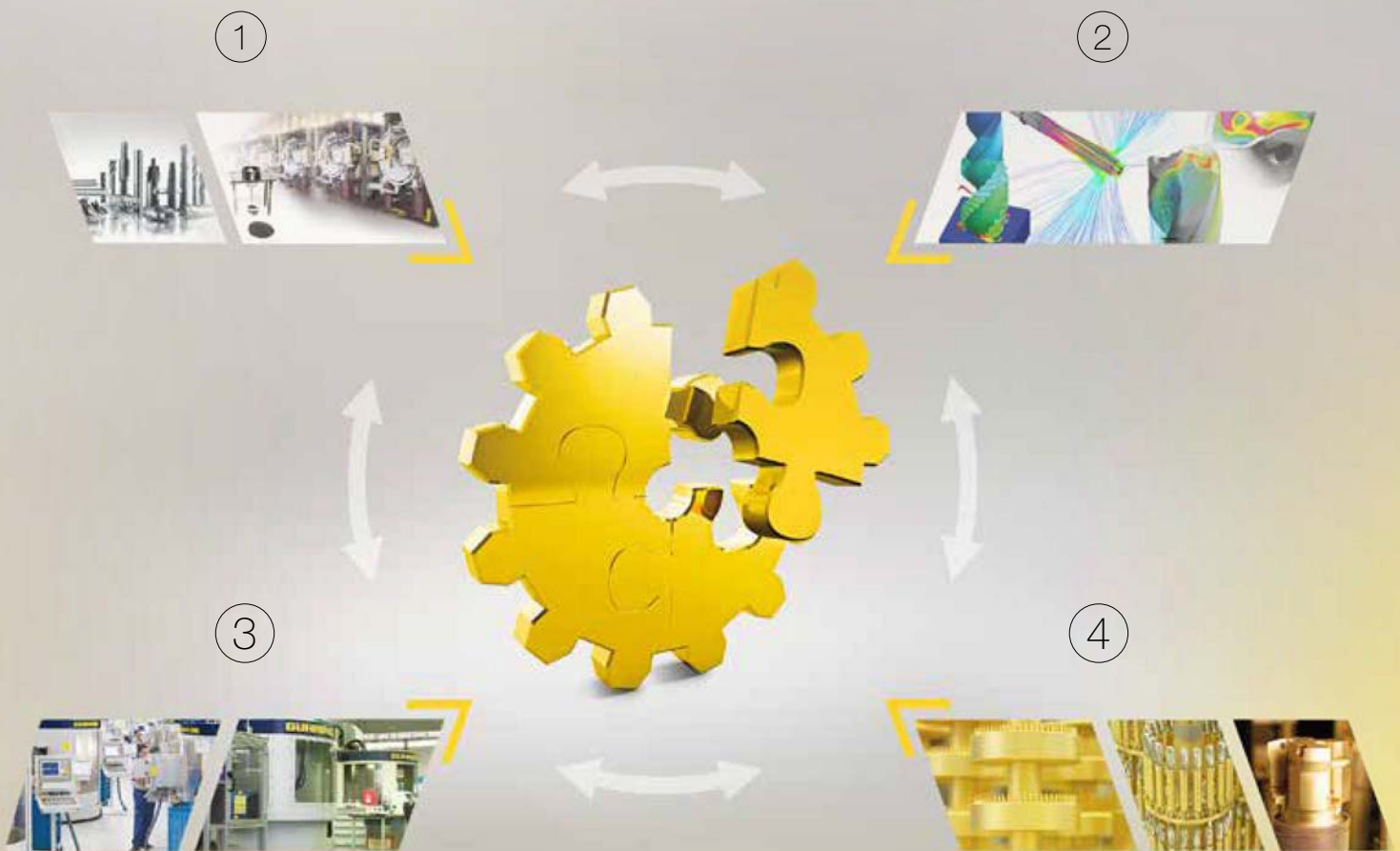

① TOOL MATERIALS

Own carbide production

② GEOMETRIES

Own R&D for tool development

③ SYSTEMS AND MACHINE TOOL DIVISION

Own machine tool division and own systems development

④ COATINGS

Own coating machines and own coating development

GE100



- + high level of stock availability*
- + extremely short delivery times*
- + one holder, flexible adaptation, maximum functionality*

Design, scheduling, production, stockholding and despatch are all in one location

Guhring has specialised in the GE100 system production in Markt Erlbach. Multi-functional tooling systems have been manufactured at this location for in excess of 25 years – a proven concept. The division pools expert user knowledge gained from the end machining sector and solves customer specific enquiries quickly and competently. Short delivery times, high stock availability and on-time delivery speak for themselves.

Multi-functional tooling systems for end machining

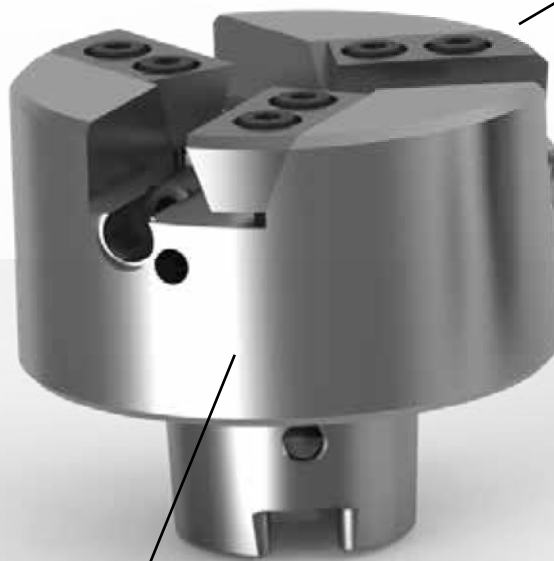
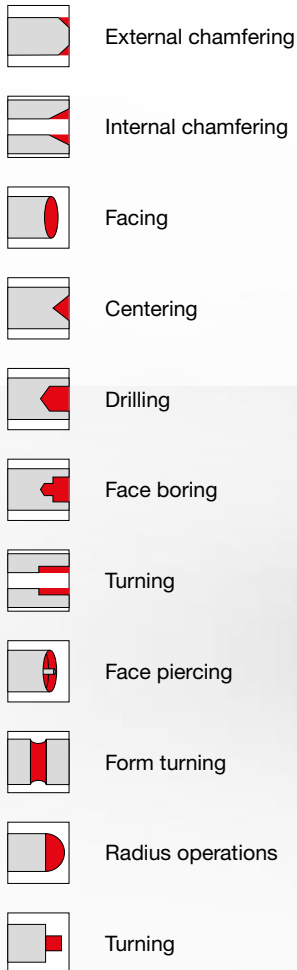

Depending on the machining tasks, the **tool heads** (p. 21) are available with 2, 3, or 4 adaptors for tool holders.

Thanks to an interface on the short taper GE100 tools can be **combined with all tool holders** (p. 35).

FIELDS OF APPLICATION

- Machining of pipes, shafts and housings
- Machining bars
- Stud machining
- Facing and centring as preparation for turning between centres

USERS

- Manufacturers of long tubes
- Manufacturers of pipe and valve fittings
- Automotive industry and engine manufacturers
- Armature industry
- Steel manufacturers

Bore for holding clamping sleeves for centre and step drills. Simple fitting of the drilling tool from the outside.

Basic body

Clamping wedge

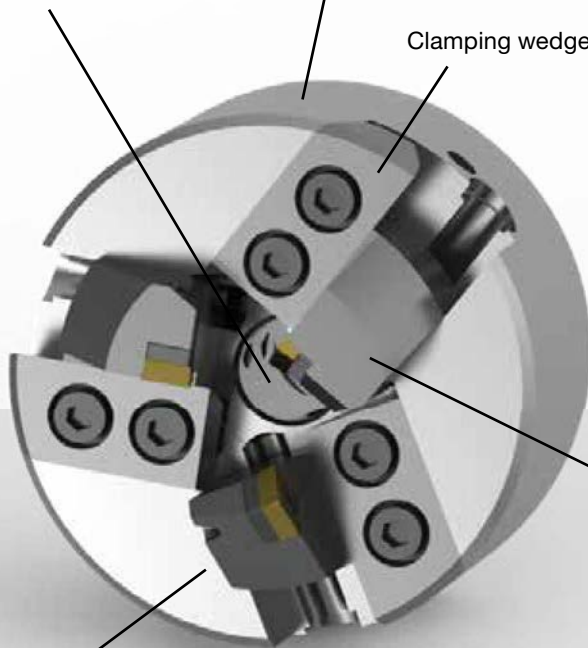

Our clamping holders (p. 24) are **axially and radially adjustable**, via adjusting screws, making the machining of different workpiece diameters possible with only one tool.

Two to four axially and radially adjustable clamping holders in combination with a centre or step drill perform the complete machining in seconds. Tool heads with five clamping holders or more are available on request.

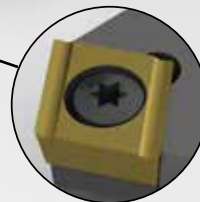
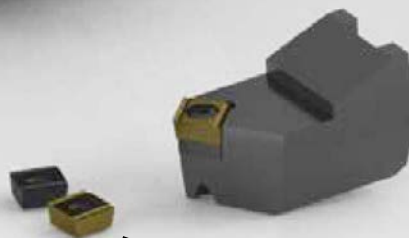

Precision ground **ISO indexable inserts** (p. 36) with application oriented chip breaker (index accuracy $\pm 0.013\text{mm}$).

Combine up to 5 OPERATING STEPS
with only one TOOL!

STEEL

general steel types from low to high tensile strength (500-1400 N/mm²); high tensile strength heat treatable steels and tool steels (up to 48 HRC); hardened steels and chilled cast iron in excess of 63 HRC



CAST IRON

Cast iron types such as grey cast iron (GG25), spheroidal graphite iron, malleable cast iron and cast steel alloys, abrasive special cast alloys



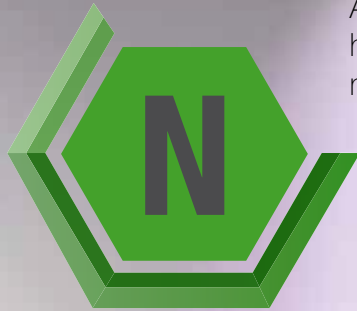

ALUMINIUM

Aluminium wrought alloys;
high tensile aluminium; cast silicon aluminium;
non-ferrous metals



CONTENT

01

INDUSTRIES

Page 10

Automotive

Page 10

Sanitary and building technology

Page 14

02

SPECIAL SOLUTIONS

Page 16

03

TOOL RANGE

Page 20

System characteristics

Page 20

Tool heads

Page 21

Clamping holders

Page 24

Floating holders

Page 28

BF 100

Page 30

Clamping sleeves

Page 32

Centre drills

Page 33

Step drills for centering

Page 34

Adapters, holders

Page 35

04

INDEXABLE INSERTS

Page 36

05

TECHNICAL SECTION

Page 46

ADVANTAGES

- + great flexibility thanks to modular design
- + combining several operating steps
- + simple handling
- + precise run-out and concentricity
- + versatile ISO indexable insert range



AUTOMOTIVE

Special requirements – multi-functional solutions

Many different components in vehicles of any type incorporate countless pipes and shafts. In addition, a large number of housings require multiple operating steps in various materials.

The modular design of the GE100 system enables the assembly of the modular tool from standard products. Individual customer solutions are designed according to the machining strategy of the user. Inserts in different tool material qualities, various coatings as well as insert and tool geometries also allow the economically efficient machining of a large number of materials.



Application examples

- Pneumatic springs
- Side impact protection
- Transmission housings
- Camshaft and balance shaft ends
- Hydro-mountings
- Seat cross struts
- Stub axles
- Drive shafts
- Shock absorber body and pistons
- Fuel and oil lines, injection systems, brake lines
- Anti-roll bars

CHALLENGE

Seat cross strut



When machining hardened and tempered tubes for vehicle seats special conditions demand that the finished diameters and lengths are provided with corresponding chamfers and tolerances. The process requires DIN ISO indexable inserts as well as good chip evacuation.



tool
1



tool
2

V_c : 120 m/min
 f_n : 0,15 mm/rev.
 a_p : 2 mm

Two tool heads machine the left and the right side with only two holders for a good chip flow. For the turning operation two indexable inserts on each head enable high feed rates and therefore have a positive effect on the chip formation.

CHALLENGE

OUR SOLUTION

tool
1

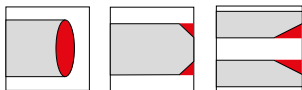

tool
2

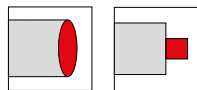

ADVANTAGES

- Standard DIN ISO indexable insert
- Quick-change system on tool head
- Short chips and good chip flow guarantee process reliability
- Uncomplicated and simple re-adjustment of tools
- Wear parts replaceable

Shock absorber



Facing, internal and external chamfering as well as turning a shock absorber reservoir tube in one operating step – and this with varying tube diameters,



V_c : 220 m/min
 f_n : 0,2 mm/rev.
 a_p : 1 mm

GE100 tool head with four holders, simultaneously tackling the machining steps. Clamping holders can be adjusted for various tube diameters.

CHALLENGE

OUR SOLUTION

tool
1

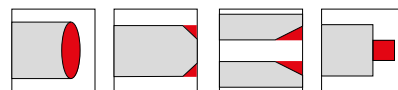

ADVANTAGES

- Short cycle time thanks to machining in one operating step
- Machining of different tube diameters with one tool
- Setting gauge enables quick modification to other tube diameters
- DIN ISO precision inserts ensure a clean and accurate workpiece surface finish

Brake line



Turning a brake line made of three different materials. The aluminium steel core must not be damaged.

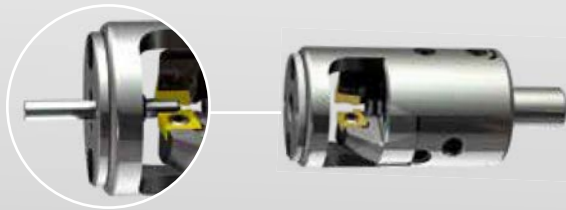

V_c : 100 m/min
 f_n : 0,2 mm/rev.
 a_p : 1 mm

One **tool head with guide bracket** supports the brake line during the machining process. Consequently, only the plastic coating and a thin layer of the core is removed. In addition, facing and chamfering operations are performed in the same operating step.

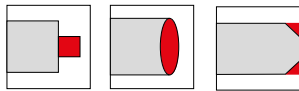

- The guide bracket prevents the workpiece from deviating
- Multiple operating steps are carried out simultaneously
- Economic solution with DIN ISO indexable inserts
- With this system it is possible to even machine workpieces protruding far out of the clamping device

Valve body



When machining aluminium valve bodies, several diameters and chamfers have to be machined in one operating step and with the shortest cycle times. The tooling concept should include a drilling tool. Furthermore, the fine adjustment of the diameter tolerances must be provided.



V_c : 250 m/min
 f_n : 0,3 mm/rev.
 a_p : 5 mm

Tool heads with internal cooling connection and centre bore. The holders are designed with two inserts for large turning operations. The symmetrical construction permits high speed application.

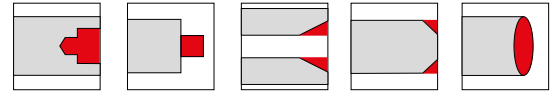

- Total machining process with one stroke
- Extremely short cycle time
- Internal cooling optimises chip flow
- Smooth operation even at high speed
- Application of DIN ISO indexable inserts
- Low tool inventory
- Stable process despite a wide variety of settings
- Quick conversion and modification of tools

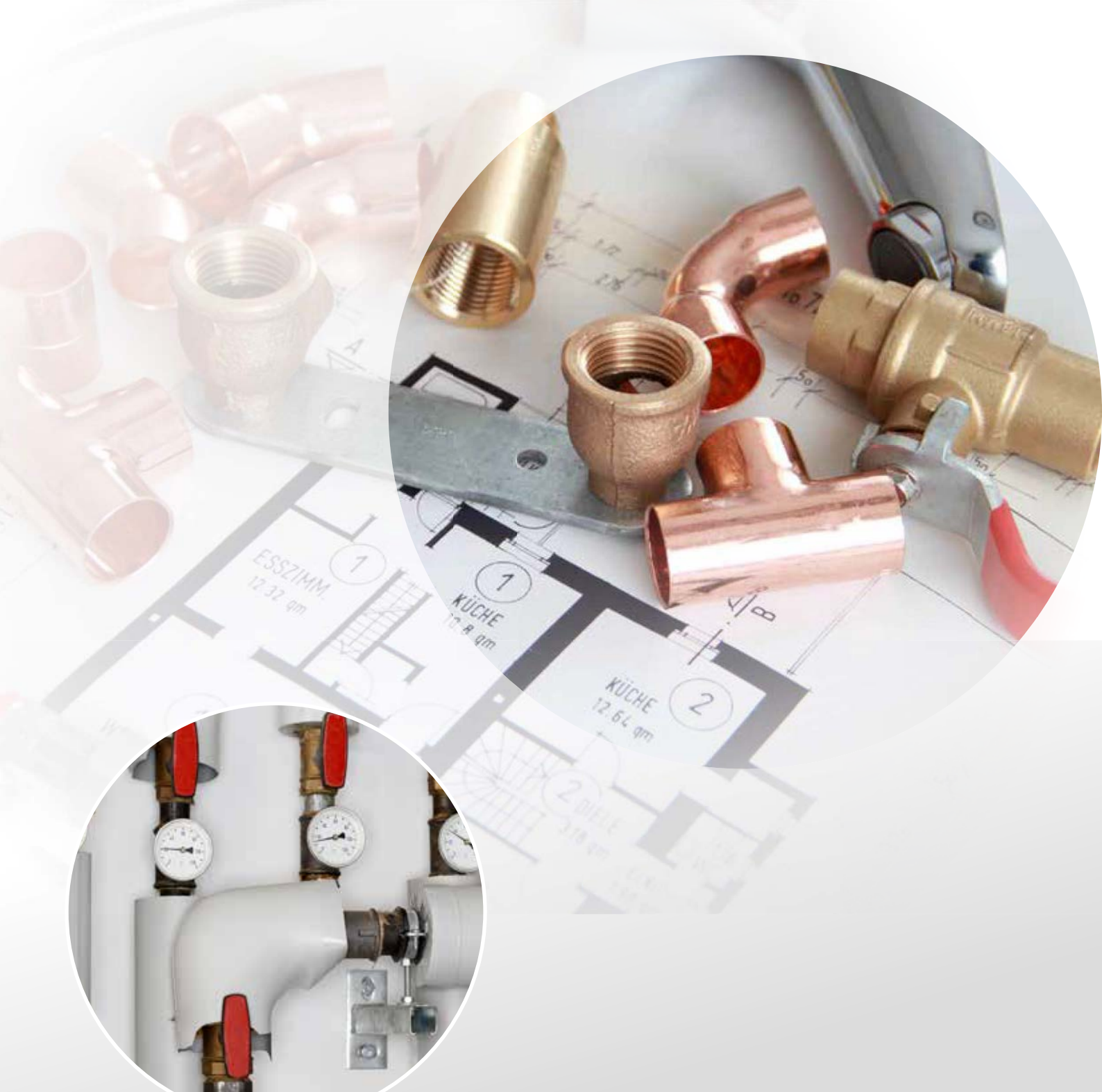

SANITARY AND BUILDING TECHNOLOGY

Pipes and containers for the sanitary and building technology are often manufactured by machining processes. The multi-functional tooling system GE100 provides economical machining.

Application examples

- Water pipelines
- Pipe fittings
- Armatures
- Toilet seat fittings
- Heating manifolds
- Water cylinders

Pipe fittings and pipes

CHALLENGE



Manufacture of complex profile contours on the simplest of machines in only one operating step.



V_c : 170 m/min
 f_n : 0,25 mm/rev.
 a_p : 2 mm

Tool head with profile inserts. The geometry of the insert corresponds with the finished contour. To keep the cutting forces low, the contour is distributed over three inserts.

OUR SOLUTION



ADVANTAGE

- High-quality profiled components can be manufactured on a simple machine
- Thanks to exchangeable form inserts the tool is always available as a standard item
- A consistent level of quality is ensured
- Easy handling guarantees process reliability
- Various coatings allow flexible machining of different materials

Pipes for flushing cisterns

CHALLENGE



Stainless steel formed pipes must have precisely defined chamfer widths. The out-of-roundness of the pipes is however often up to 1 mm and leads to an inaccurate chamfer geometry. In extreme cases a sharp edge remains. The scrap rate is in excess of 50%.



V_c : 50 m/min
 f_n : 0,1 mm/rev.
 a_p : 3 mm

GE100 with linear guided floating holder for internal and external facing as well as length-adjustable chamfer tool holder. The linear guidance prevents tilting and ensures consistent chamfer geometry. The chamfer length is set via a length-adjustable chamfer tool holder.

OUR SOLUTION

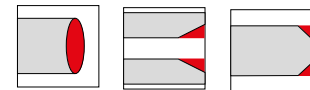

ADVANTAGE

- Process reliable production of a defined chamfer
- Considerable reduction in scrap rate of up to 95%
- Application of standard DIN ISO indexable inserts
- Uncomplicated tool simplifies the work of machine operators

GE100 FLOATING HOLDERS

Guhring's GE100 floating holder is the optimal solution for end machining of 'out-of-roundness' pipes such as facing, internal and external chamfering in one operating cycle. Thanks to the Guhring developed sprung floating holder clean and consistent chamfers are achieved even with extremely out-of-roundness pipes.

- Compensates for out-of-roundness and wall thickness differences of pipes
- Consistent chamfer width especially with small chamfers
- Compensates inaccuracies of rotating axis to clamping axis
- Combines several operating steps
- More floating travel possible
- Suitable for extremely thin pipes
- Thanks to various adapters suitable for use on any machine

CONCENTRICITY

LINEAR

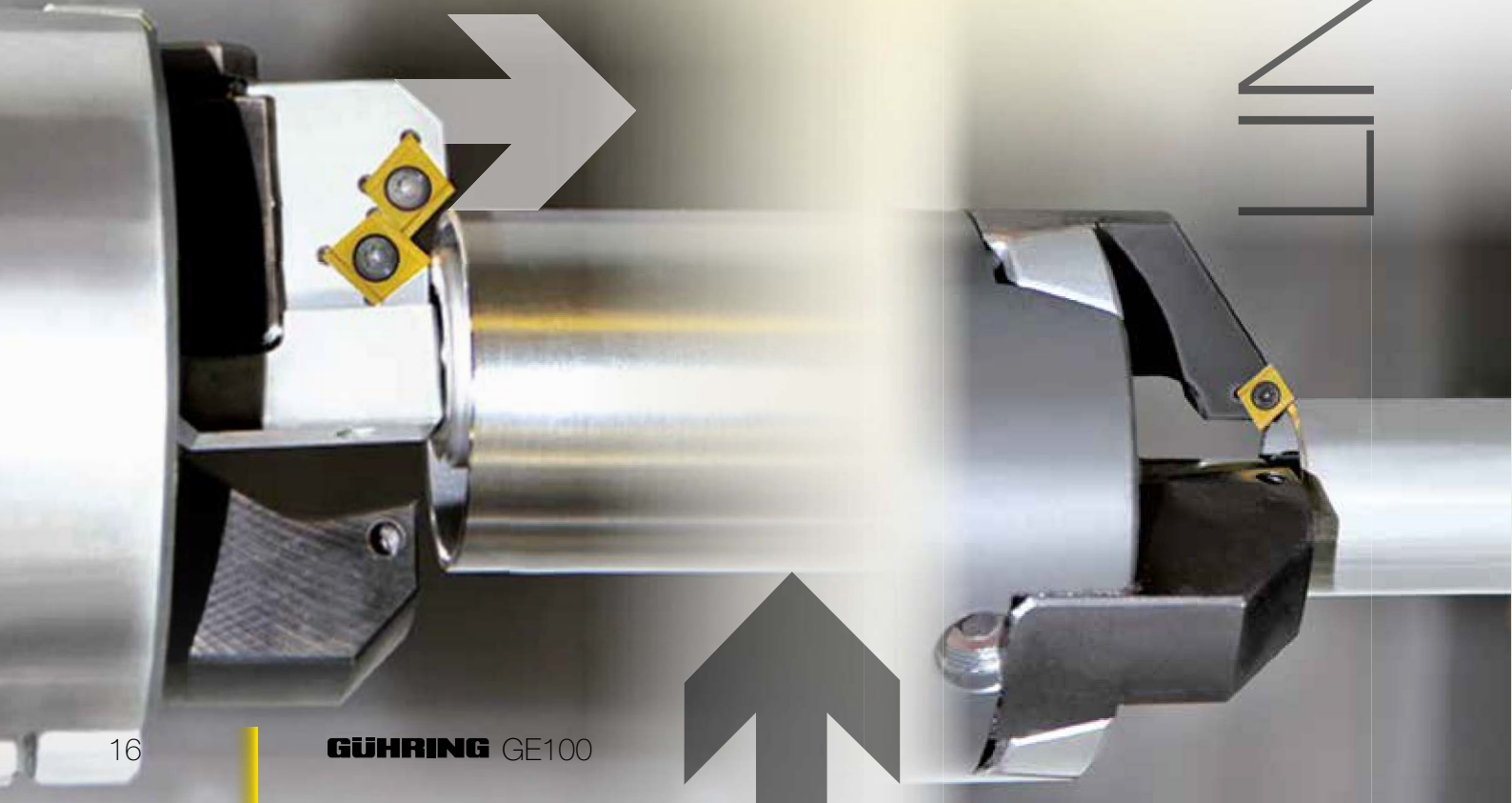



LINEAR FLOATING HOLDERS

Linear sprung floating holders are especially well suited to a large pendulum stroke. The linear guidance prevents the pendulum being pushed away and therefore guarantees a consistent chamfer angle.

Linear floating holders are currently available as a special tool.

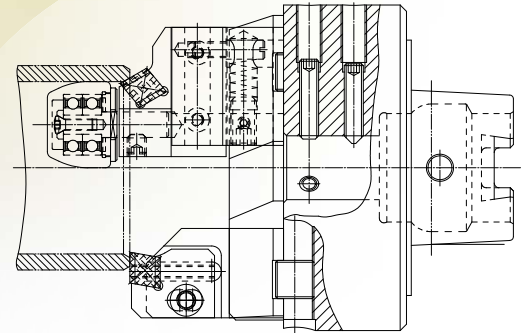

Linear sprung floating holder

EXTERNAL AND INTERNAL FLOATING HOLDERS

For extremely thin-walled pipes and small chamfers – the newly developed external and internal floating holder. Pipes with $\text{Ø } 18 \times 1$ and max. $0.05 \times 45^\circ$ chamfer are not a problem.

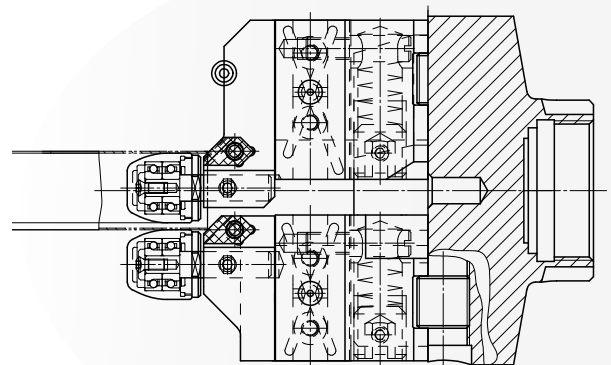

Linear sprung floating holder

CLASSIC FLOATING HOLDERS

Classic floating holders are pivoted by a bolt and suitable for the internal chamfering from an internal pipe diameter of 14 mm. They can be ordered via the standard GE100 range.

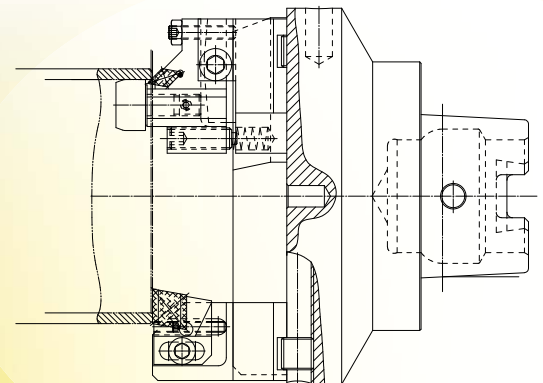

Floating holder pivoted by bolt

All floating holders are clamped on GE100 tool heads. They allow the adaptation to all recognised machine holders and quick-change systems.

SPECIAL SOLUTIONS

GE100 with guide bracket

A sealed grooved ball bearing with a guide bushing guarantees absolutely accurate concentricity. Radial adjustable tool holders allow the precise setting of the diameter and the chamfer.

ADVANTAGES AT A GLANCE:

- Machining of long, slender components
- Protrusion length 10xD
- Large material removal in one operating step
- Tool and workpiece stabilise each other
- Rigid clamping for minimal indexable insert wear

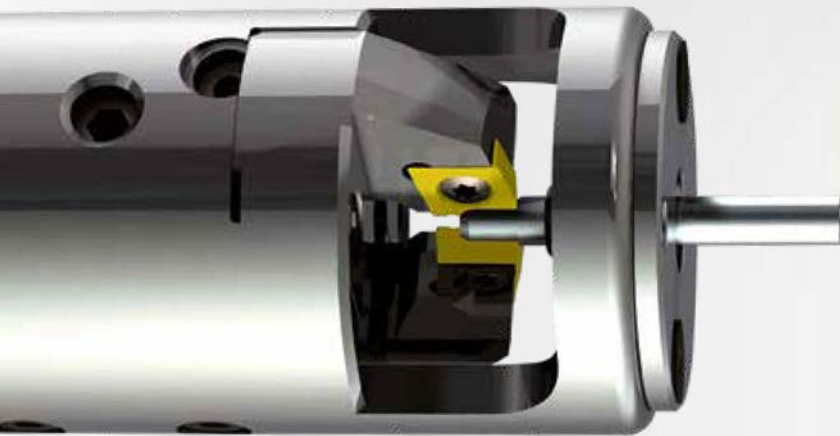

TWA adjustment

GE100 with threaded wedge adjustment

- Adjustable indexable inserts for maximum accuracy
- Simple indexable insert adjustment possibilities thanks to threaded wedge adjustment (TWA)
- Adjustment range of indexable insert with TWA is up to 0.30 mm diameter

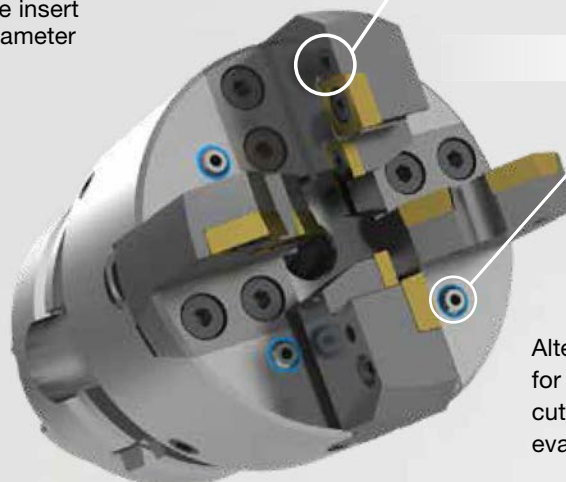

Cooling

Alternative with cooling elements for providing coolant to the cutting edge and to improve chip evacuation.



Form operations

Special solutions for special demands

Standard stocked insert blanks can be formed quickly and individually to the machining task.

BF 100

Drilling, chamfering and facing in one operating step.

Flexible positioning of indexable inserts to flute geometries of drilling tools in order to provide good chip evacuation.



Coning in no time at all

Simple, quick and clean –

with Guhring's new coning device for the machining of shafts the ends of round materials can now be machined in no time at all. The coning device is simply clamped on a commercially available handheld drill.

There is a choice of two semi-standard coning device designs with 45° chamfer angle:



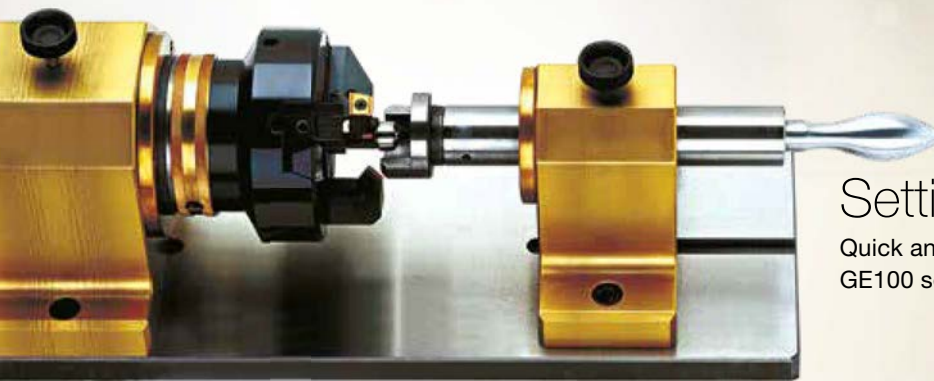



- One design for material diameter 4 to 14 mm with DIN indexable insert CC..09T3...
- One design for material diameter 14 to 30 mm with DIN indexable insert DCMT 1504...



Setting device

Quick and simple adjustment with the GE100 setting device.

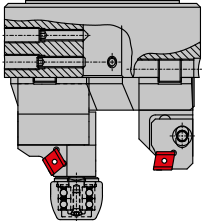
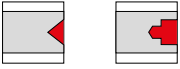
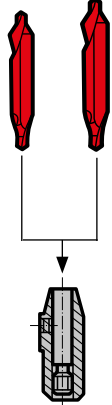
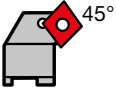
SYSTEM CHARACTERISTICS

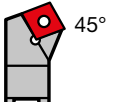
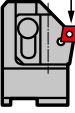
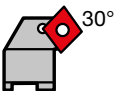
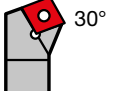
Radially adjustable tool holders				Special solutions	Clamping sleeves
 Internal chamfering	 External chamfering	 Turning	 Facing	 Floating holder p. 30/31 BF 100 p. 32/33	 centering, Turning 
 45°	 Angle adjustable 15°-60°  45°	 axial adjustment	 30°  30°		

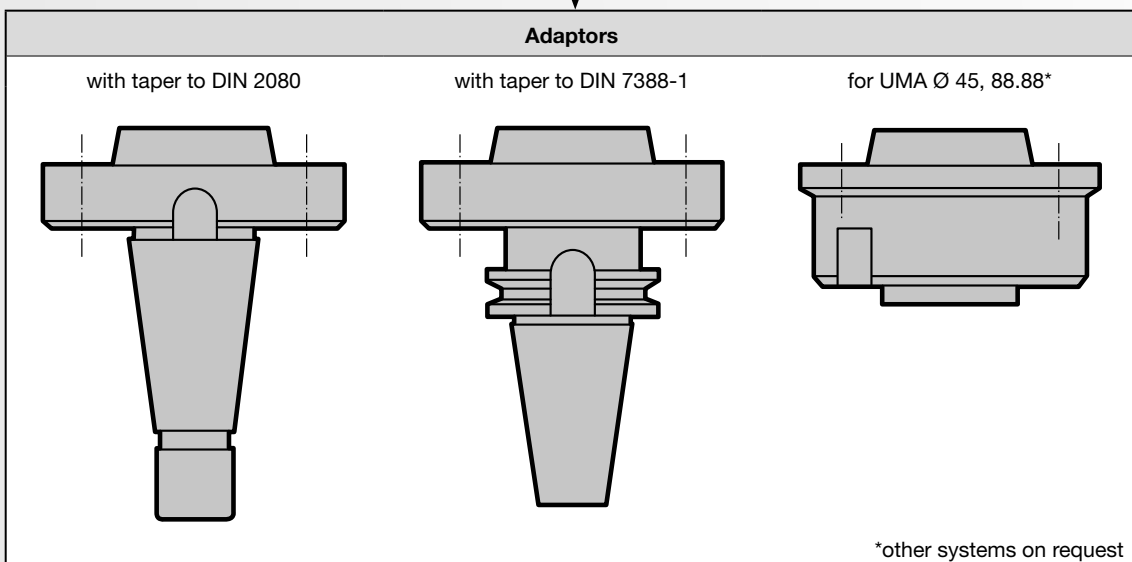
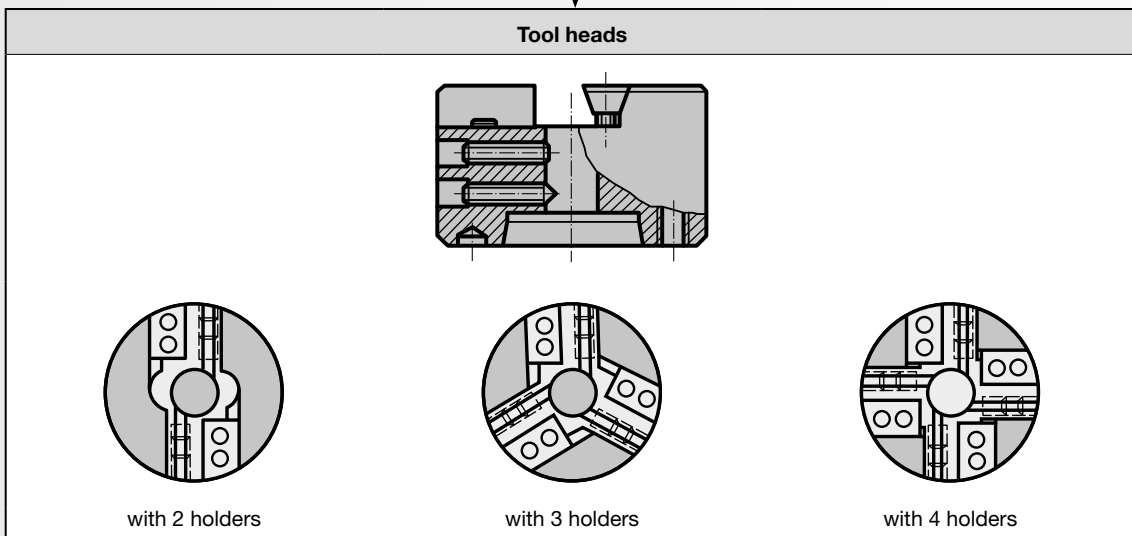

Section A - B

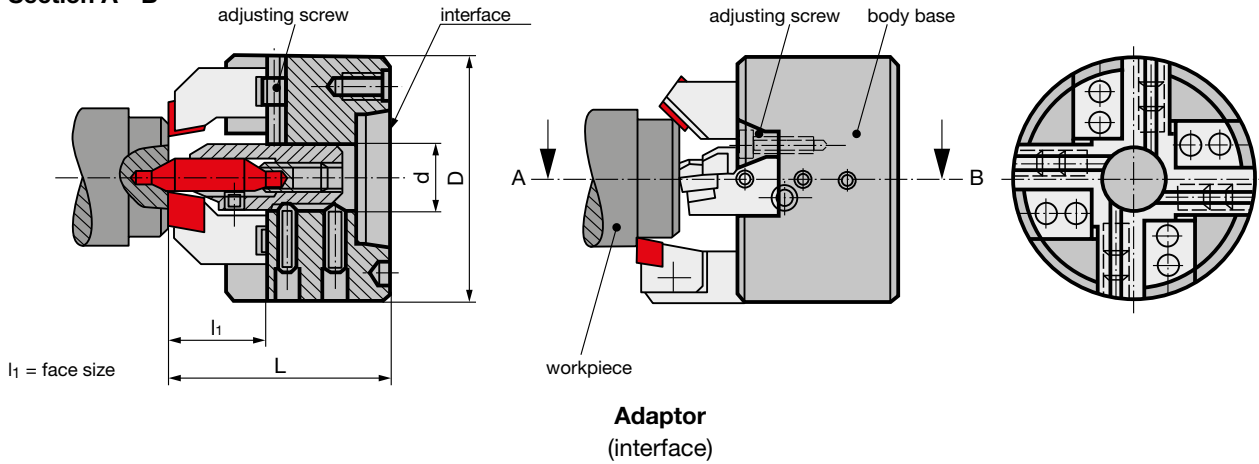

**Adaptor
(interface)**

Ø 16x25

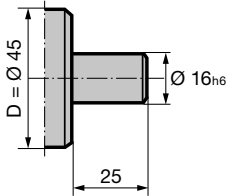

B25 DIN 1835

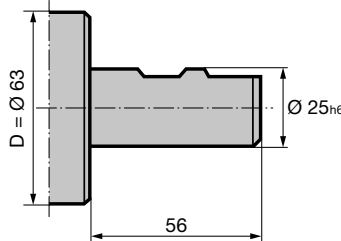

Ø 30x10 deep

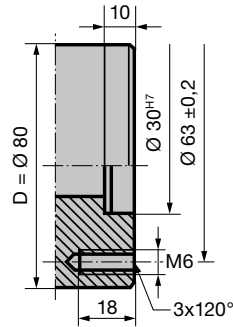

C3 ... C8
DIN ISO 702-3

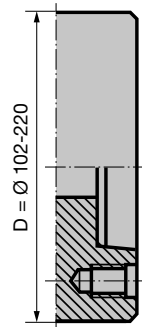

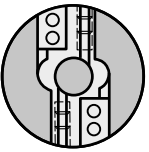
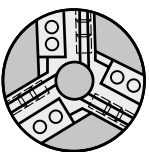
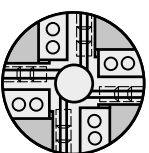
Tool head	Size	Code no.*	Availability	Dimensions				Adaptor (Interface)	V-wedge Guh. no. 6021 Code no.*	Adjust. screw Guh. no. 6022 Code no.*
				D mm	d mm	L mm	l1 mm			
	I	45,002	●	45	10.0	50	27	Ø 16 x 25	45,000	8,000
		Guh. no. 6001								
		63,002	●	63	10.0	50	27	B25 DIN 1835	63,000	8,000
		80,002	●	80	20.0	75	35	Ø 30 x 10 tief	80,000	12,000
		102,002	●	102	20.0	80	35	C3 DIN ISO 702-3	102,000	12,000
		140,002	●	140	31.5	105	45	C3 DIN ISO 702-3	140,000	12,000
	I	63,001								
		63,003	●	63	10.0	50	27	B25 DIN 1835	63,000	8,000
		80,003	●	80	20.0	75	35	Ø 30 x 10 tief	80,001	12,000
		102,003	●	102	20.0	80	35	C3 DIN ISO 702-3	102,000	12,000
		140,003	●	140	31.5	105	45	C5 DIN ISO 702-3	140,000	12,000
	II	102,004	●	102	20.0	80	35	C3 DIN ISO 702-3	102,001	12,000
		Guh. no. 6003								
		112,004	●	112	31.5	100	45	C4 DIN ISO 702-3	112,001	12,000
		140,004	●	140	31.5	105	45	C5 DIN ISO 702-3	140,001	12,000

*) When ordering, please always state Guhring no. and code no.!

● on stock ○ on request

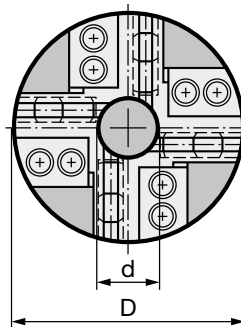
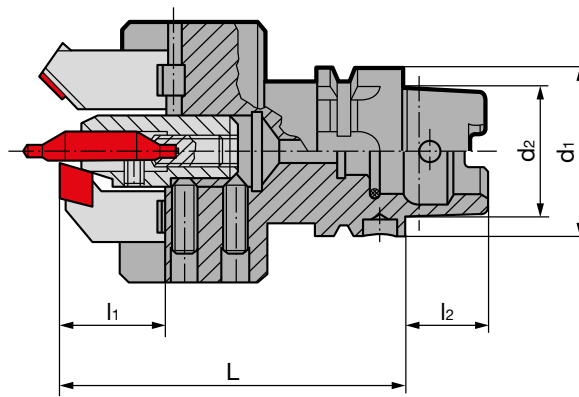

Tool head with HSK-holder, form A automatic

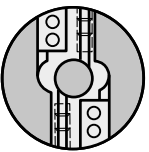
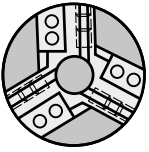
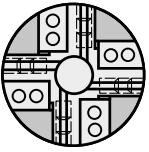
Tool head	Size	Code no.*	Dimensions							HSK-holder
			D mm	d mm	d ₁ mm form A	d ₂ mm	L mm form A	l ₁ mm	l ₂ mm	
2 Clamp. holders form A Guh. no. 6041	I	45,032	45	10.0	32	24	85	27	16	32
		63,040	63	10.0	40	30	85	27	20	40
	II	80,050	80	20.0	50	38	105	35	25	50
		102,063	102	20.0	63	48	105	35	32	63
	III	112,080	112	31.5	80	60	131	45	40	80
		140,100	140	31.5	100	75	131	45	50	100
3 Clamp. holders form A Guh. no. 6042	II	63,040	63	10.0	40	30	85	27	20	40
		80,050	80	20.0	50	38	105	35	25	50
	III	102,063	102	20.0	63	48	105	35	32	63
		112,080	112	31.5	80	60	131	45	40	80
	III	140,100	140	31.5	100	75	131	45	50	100
4 Clamp. holders form A Guh. no. 6043	III	102,063	102	20.0	63	48	105	35	32	63
		112,080	112	31.5	80	60	131	45	40	80
	III	140,100	140	31.5	100	75	131	45	50	100

*) When ordering, please always state Guhring no. and code no.!

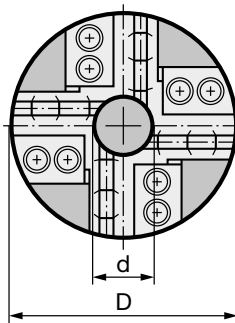
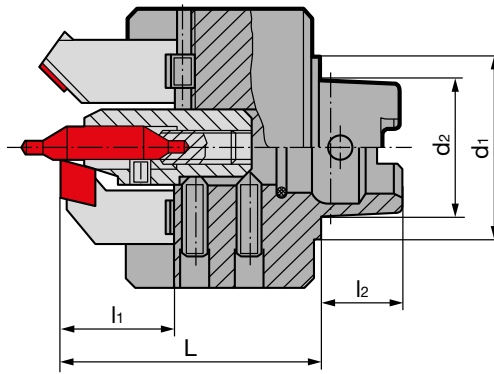



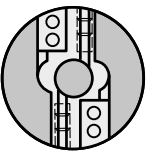
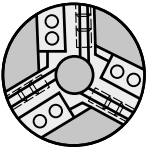
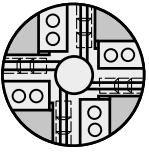

Tool head with HSK-holder. form C manual with increased locating face

Tool head	Size	Code no.*	Dimensions							HSK-holder
			D mm	d mm	d1 mm form C	d2 mm	L mm form C	l1 mm	l2 mm	
2 Clamp. holders	I	45,032	45	10.0	40	24	59	27	16	32
		form C Guh. no. 6031	63,040	63	10.0	50	30	59	27	20
	II	80,050	80	20.0	63	38	75	35	25	50
		102,063	102	20.0	80	48	75	35	32	63
	III	112,080	112	31.5	100	60	100	45	40	80
		140,100	140	31.5	125	75	100	45	50	100
3 Clamp. holders	I	63,040	63	10.0	50	30	59	27	20	40
		form C Guh. no. 6032	80,050	80	20.0	63	38	75	35	25
	II	102,063	102	20.0	80	48	75	35	32	63
		112,080	112	31.5	100	60	100	45	40	80
	III	140,100	140	31.5	125	75	100	45	50	100
4 Clamp. holders	II	102,063	102	20.0	80	48	75	35	32	63
		form C Guh. no. 6033	112,080	112	31.5	100	60	100	45	40
	III	140,100	140	31.5	125	75	100	45	50	100

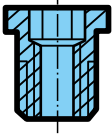
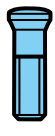
*) When ordering, please always state Guhring no. and code no.!

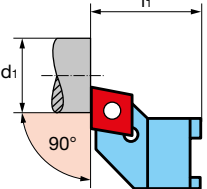

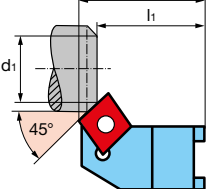
Clamping holders, radially adjustable

Clamp. holders type	Code no.*	Facing size	Total length	Machining dia. range		for Tool head		for insert type	Spare parts		
									Tungst. carb. base	Threaded ring	Clamp. screw
									Guh. no. 6126 Code no.	Guh. no. 6127 Code no.	Guh. no. 6128 Code no.
											
		l1 mm	l2 mm	d1 min. d1 max. mm	D mm	Size					
Guh. no. 6101  Holder for facing operations 	11,006	27	-	0 - 20	45	I	CCH...0602	-	-	2,501	
	12,006			5 - 35	63						
	11,009			0 - 22	45						
	21,009	35	-	0 - 25	80	II	CCH...09T3	9,000	5,000	3,501	
	22,009			0(8**) - 44	102						
	21,012			10 - 40	80						
	22,012			10(17**) - 62	102						
	31,012			0 - 30	80						
	32,012			0(8**) - 50	102						
	31,016	45	-	12 - 40	80	III	CNH...1204	12,000	6,000	4,000	
	32,016			13 - 62	102						
	31,016			0 - 40	112						
	32,016			0 - 70	140						
	41,016	60	-	35 - 70	112	IV	CNH...1606	16,000	8,000	5,000	
	42,016			35 - 100	140						
	41,019			0 - 46	112						
42,019	0 - 76			140							
Guh. no. 6102  Holder for ext. chamfering operations 	11,006	27	30.4	8 - 13	45	I	CCH...0602	-	-	2,501	
	12,006			10 - 30	63						
	11,009			12 - 17	45						
	12,009	32.7	-	8 - 12	45	I	CCH...09T3	-	-	3,500	
	12,009			9 - 30	63						
	21,009	35	40.7	-	9 - 23	80	II	CCH...09T3	9,000	5,000	3,501
	22,009				9(18**) - 45	102					
	21,012				20 - 33	80					
	22,012	43.0	-	-	20(29**) - 55	102	II	CNH...1204	12,000	6,000	4,000
	22,012				9 - 20	80					
	31,012	45	53.0	-	9(17**) - 44	102	III	CNH...1204	12,000	6,000	4,000
	32,012				20(29**) - 55	102					
	31,016				15 - 38	112					
	32,016				15 - 68	140					
	41,016	60	63.3	-	38 - 60	112	IV	CNH...1606	16,000	8,000	5,000
	42,016				38 - 90	140					
41,016	15 - 38				112						
42,016	15 - 68				140						
41,016	60	63.3	-	38 - 90	140	IV	CNH...1606	16,000	8,000	5,000	
42,016				36 - 74	170						
42,016				36 - 127	220						
42,016	60	63.3	-	73 - 114	170	IV	CNH...1606	16,000	8,000	5,000	
42,016				73 - 167	220						

*) When ordering, please always state Guhring no. and code no.!

**) Dimensions for tool head with 4 adaptors, Ø 102 mm (6003 102,004)!

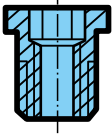
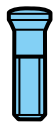
Clamping holders, radially adjustable

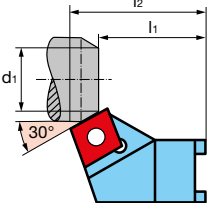
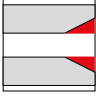
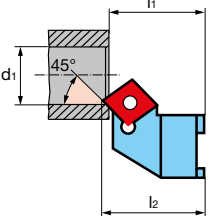
Clamp. holders type	Code no.*	Facing size	Total length	Machining dia. range		for Tool head		for insert type	Spare parts		
				d1 min.	d1 max.	D mm	Size		Tungst. carb. base	Threaded ring	Clamp. screw
									Guh. no. 6126 Code no.	Guh. no. 6127 Code no.	Guh. no. 6128 Code no.
		l1 mm	l2 mm	mm							
Guh. no. 6103											
 <p>Holder for ext. chamfering operations</p> 	11,006	27	31.5	8 - 13	45	I	CCH...0602	-	-	2,501	
	12,006			10 - 30	63						
	11,009			8 - 12	45						
	12,009			10 - 30	63						
	21,009	35	42.3	8 - 21	60	II	CCH...09T3	9,000	5,000	3,501	
	22,009			8(17**) - 43	102						
	21,012			20 - 32	60						
	22,012			20(29**) - 54	102						
	31,012	45	55.1	8 - 20	80	III	CNH...1204	12,000	6,000	4,000	
	32,012			8(17**) - 43	102						
	31,016			15 - 38	112						
	32,016			15 - 68	140						
	41,016	60	70.9	38 - 60	112	IV	CNH...1606	16,000	8,000	5,000	
	42,016			38 - 90	140						
	15 - 38			112							
	15 - 68			140							
Guh. no. 6104											
 <p>Holder for int. chamfering operations</p> 	11,006	27	29.0	7 - 15	45	I	CCH...0602	-	-	2,501	
	12,006			14 - 30	63						
	11,007			7 - 15	45						
	12,007			14 - 30	63						
	21,009	35	36.5	7 - 22	63	II	CCH...09T3	9,001	5,000	3,501	
	22,009			14 - 16	45						
	21,012			18 - 34	63						
	22,012			15 - 27	80						
	31,012	45	47.0	15(23**) - 49	102	III	CNH...1204	12,001	6,000	4,000	
	32,012			25 - 35	80						
	31,016			25(30**) - 57	102						
	32,016			16 - 25	80						
	41,016	60	68.0	16(24**) - 46	102	IV	CNH...1606	16,001	8,000	5,000	
	42,016			25 - 35	80						
	25(30**) - 53			102							
	40 - 60			112							
			20 - 40	112							
			20 - 70	140							
			40 - 60	112							
			40 - 90	140							
			40 - 82	170							
			40 - 132	220							
			78 - 120	170							
			78 - 170	220							

*) When ordering, please always state Guhring no. and code no.!

**) Dimensions for tool head with 4 adaptors, Ø 102 mm (6003 102,004)!

Clamping holders

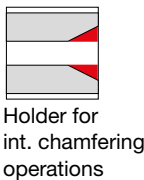
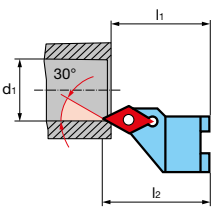

Clamp. holders, radially adjustable

Clamp. holders type	Code no.*	Facing size		Total length		Machining dia. range		for Tool head		for insert type	Spare parts		
		l1 mm	l2 mm	d1 min.	d1 max.	D mm	Size	Tungst. carb. base	Threaded ring		Clamp. screw		
								Guh. no. 6126 Code no.	Guh. no. 6127 Code no.		Guh. no. 6128 Code no.		
Guh. no. 6105  Holder for int. chamfering operations 	11,006	27	29.5	7 - 15	45	I	CCH...0602	-	-	2,501			
	12,006			15 - 30	63								
	11,007			7 - 20	63								
	12,007			7 - 15	45								
	11,009			15 - 30	63								
	12,009			7 - 22	63								
	21,009	35	36.5	15 - 27	80	II	CCH...09T3	9,002	5,000	3,501			
	22,009			15(23**) - 49	102								
	21,012			25(35**) - 60	102								
	22,012			16 - 25	80								
	31,012	45	48.0	16(24**) - 46	102	III	CNH...1204	12,002	6,000	4,000			
	32,012			26 - 36	80								
	31,016			26(36**) - 58	102								
	32,016			15 - 40	112								
				15 - 70	140								
				40 - 60	140								
	41,016	60	70	20 - 40	112	IV	CNH...1606	16,002	8,000	5,000			
	32,016			20 - 70	140								
42,016	40 - 60			112									
			40 - 90	140									
			40 - 82	170									
			40 - 132	220									
			78 - 120	170									
			78 - 170	220									

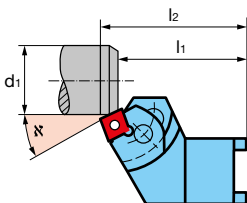
Clamping holders, axially, radially and angular adjustable

Clamp. holders type	Code no.*	Angle adjustment range		Dimensions		Machining dia. range d1 min. d1 max. mm	for Tool head		for insert type
		∞ min.	max	l1 mm	l2 mm		D mm	Size	
Guh. no. 6111 Holder with adjustable angle for external chamfering 	80,000	15° - 60°	35	39.5	12 - 21	80	II	CCH...0602	
					12 - 44	102			
	112,00	15° - 60°	45	54.5	16 - 35	112	III	CNH...1204	
					16 - 65	140			
	170,00	15° - 60°	60	76.5	30 - 67	170	IV	CNH...1906	
					30 - 120	220			

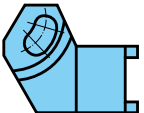
Components for Guhring no. 6111

Basic holder	Code no.*	Holder inserts	Code no.*	Clamping screw	Code no.*	for holder Guhring no. 6111 Code no.*
Guh. no. 6112		Guh. no. 6113		Guh. no. 6128		
	80,000		20,006		2,501	80,000
	112,000		30,012		4,002	112,000
	170,000		40,019		5,000	170,000



*) When ordering, please always state Guhring no. and code no.!

**) Dimensions for tool head with 4 adaptors, Ø 102 mm (6003 102,004)!

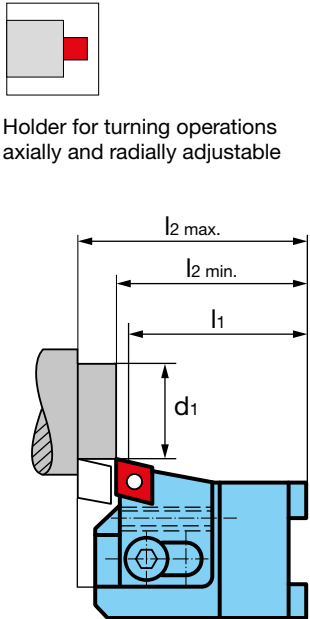
Clamping holders, axially, radially and angular adjustable

Clamp. holders type	Length adjustment range		Code no.*	Facing size l1 mm	Machining dia. range** d1 min. d1 max. mm	for Tool head		for insert type																		
	l2 min. mm	l2 max. mm				D mm	Size																			
Guh. no. 6114	35 - 42	42 - 49	80,000	35	11.0 - 25.0	80	II	CCH...0602																		
 <p>Holder for turning operations axially and radially adjustable</p>	42 - 49	49 - 56	80,001						4.0 - 28.0	102	II	CNH...1204														
	49 - 56	55 - 65	80,002										102,002	102	II	CCH...09T3										
	35 - 45	60 - 70	102,000														102,003	102	II	CNH...1204						
	45 - 55	40 - 50	102,001																		102,004	102	II	CCH...09T3		
	55 - 65	50 - 60	102,002																						102,005	102
	40 - 50	60 - 70	102,003		102,013	102	II	CCH...09T3																		
	50 - 60	40 - 50	102,004						102,014	102	II	CNH...1204														
	60 - 70	50 - 60	102,005										102,015	102	II	CCH...09T3										
	40 - 50	60 - 70	102,013														112,000	6.0 - 35.0	112	III						
	50 - 60	45 - 55	102,014																		112,001	6.0 - 65.0	140	III		
	60 - 70	55 - 65	102,015																						112,002	140
	45 - 55	65 - 75	112,000	112,010	140	III	CCH...09T3																			
55 - 65	45 - 55	112,001	112,011					140	III	CNH...1204																
65 - 75	55 - 65	112,002									112,012	140	III	CCH...09T3												
45 - 55	65 - 75	112,010													112,011	140	III	CNH...1204								
55 - 65	65 - 75	112,011																	112,012	140	III	CCH...09T3				
65 - 75		112,012																								

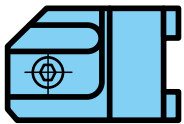
Components for Guhring no. 6114

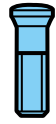
Basic holder	Code no.*	Holder inserts	Code no.*	Clamping screw	Code no.*	for holder Guh. no. 6114 Code no.*		
Guh. no. 6115		Guh. no. 6116		Guh. no. 6128				
	80,000		20,006		2,501	80,000		
	80,001					80,001		
	80,002					80,002		
	102,000		23,006		4,002	102,000		
	102,001					102,001		
	102,002					102,002		
	102,000					102,003		
	102,001					102,004		
	102,002					102,005		
	102,000		23,009		3,500	102,013		
	102,001					102,014		
	102,002					102,015		
	112,000		23,012		4,002	112,003		
	112,001					112,004		
	112,002					112,005		
	112,000					23,009	3,500	112,010
	112,001							112,011
	112,002							112,012

*) When ordering, please always state Guhring no. and code no.! **) without clamping sleeve

Floating holder

For tool heads from Ø 102 (Size II)

For tool heads from Ø 140 (Size III)

Piston stroke 2.5 mm

Chamfering length max. 3 mm

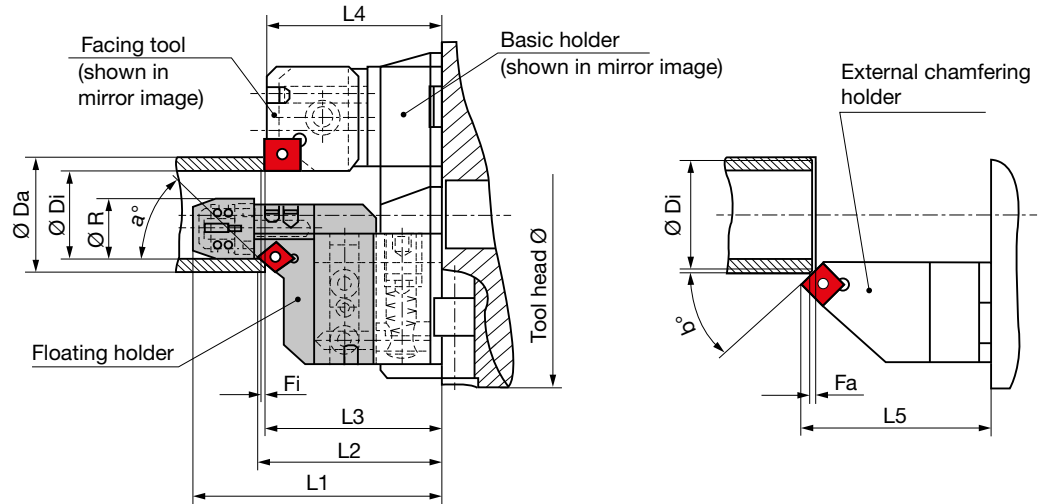

Floating holder											
Drawing no.	Material No.	Size	ØDi	ØR	α°	Fi max.	L1	L2	L3	Insert	Tool head Ø
GI 0602 2059 R	302 731 463	II	20-40	18	45°	3	69	50.5	47-50	CC .. 0602..	102
GI 0602 2061 R	302 731 464	II	20-40	18	30°	3	69	50.5	47-50	CC .. 0602..	102
GI SC09 2027 R	302 731 465	II	40-60	27	45°	3	70.5	50.7	47-50	SC .. 09T3..	102
GI SC09 2029 R	302 731 466	II	40-60	27	30°	3	70.5	50.7	47-50	SC .. 09T3..	102
GI SC09 3003 R	302 731 471	III	50-98	27	45°	3	72.5	52.7	49-52	SC .. 09T3..	140
GI SC09 3004 R	302 731 472	III	50-98	27	30°	3	72.5	52.7	49-52	SC .. 09T3..	140

Facing tool						
Drawing no.	Material No.	Size	ØDa -ØDi	L4	Insert	Tool head Ø
GP SC09 2013 R	302 732 245	II	20-57	47-50	SC .. 09T3..	102
GP SC09 2014 R	302 732 246	II	40-74	47-50	SC .. 09T3..	102
GP SC09 2013 R	302 732 245	III	48-115	49-52	SC .. 09T3..	140

Basic holder						
Drawing no.	Material No.	Size	ØDa -ØDi	L3	Insert	Tool head Ø
X 12 196	302 732 244	II	20-74	47-50	SC .. 09T3..	102
X 12 197	302 732 251	III	48-115	49-52	SC .. 09T3..	140

External chamfering holder								
Drawing no.	Material No.	Size	ØDi	β°	L5	Fa max.	Insert	Tool head Ø
GA SC09 2034 R	302 732 247	II	28-48	45°	53.2	3	SC .. 09T3..	102
GA SC09 2035 R	302 732 248	II	48-68	45°	53.2	3	SC .. 09T3..	102
GA SC09 2036 R	302 732 249	II	28-48	30°	53.5	3	SC .. 09T3..	102
GA SC09 2037 R	302 732 250	II	48-68	30°	53.5	3	SC .. 09T3..	102
GA SC09 3009 R	302 732 252	III	56-111	45°	55.2	3	SC .. 09T3..	140
GA SC09 3010 R	302 732 253	III	58-112	30°	55.5	3	SC .. 09T3..	140

FLOATING HOLDER

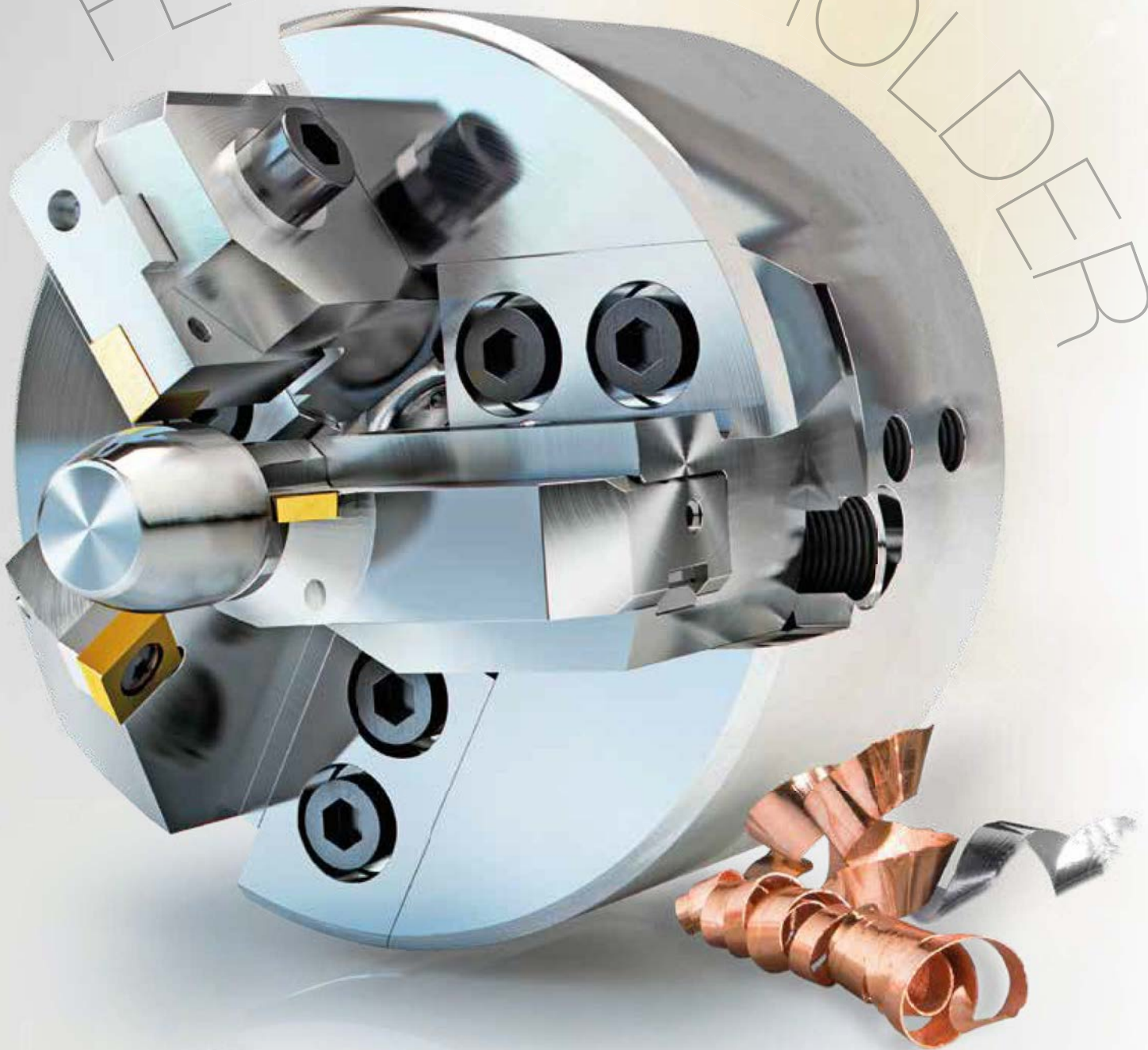

BF 100 modular drilling and chamfering tool

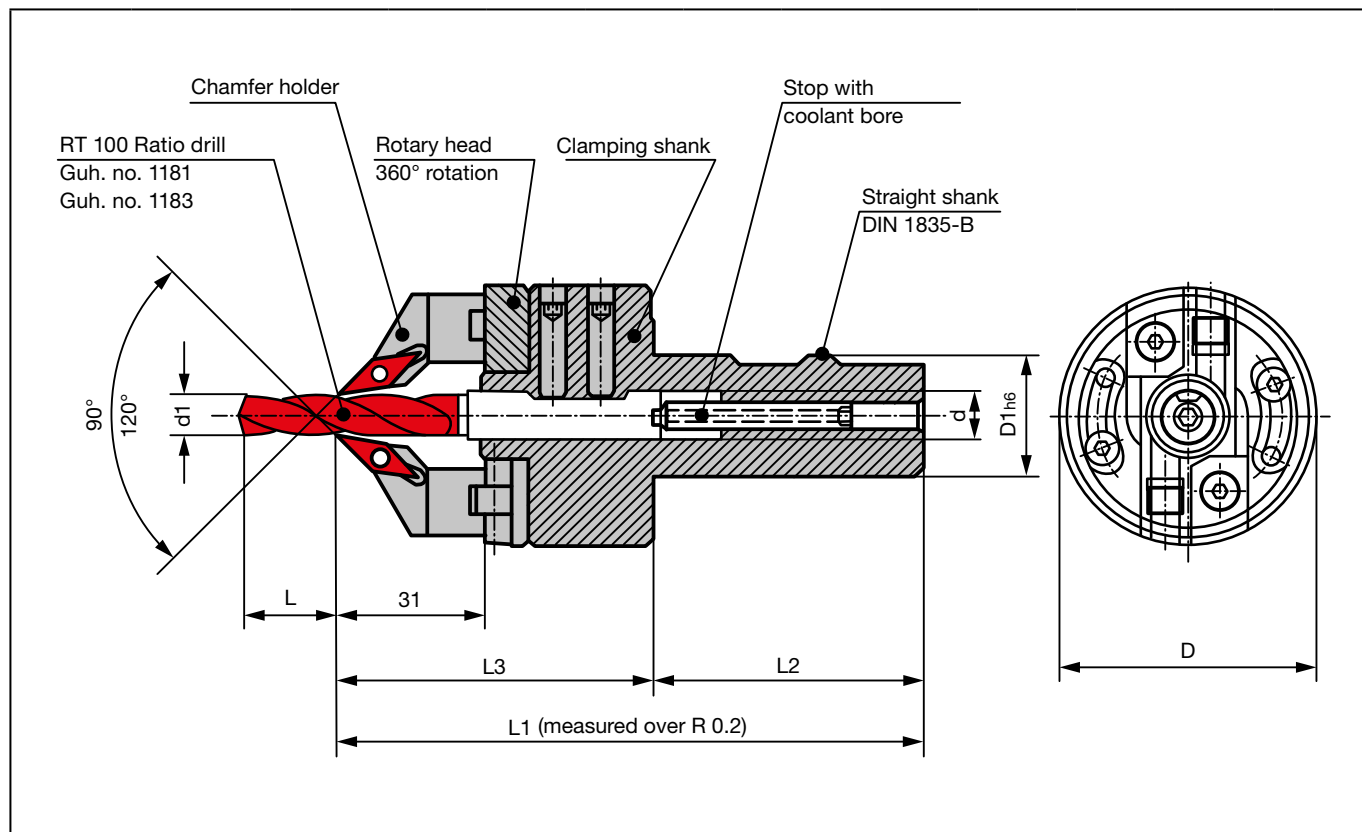

Size	Shank d Ø h6	Drilling Ø d1		Drilling depth L Guhring no.				Dimensions				
		from	up to	1181		1183		D1	D	L1	L2	L3
106	6	5.0	6.0			12	17					
108	8	6.1	8.0	2	14	14	26					
110	10	8.1	10.0	15	24	29	38					
112	12	10.1	12.0	22	36	38	52					
114	14	12.1	14.0	26	41	43	58					
214	14	12.1	14.0	26	40	43	57	32	63	135	50	75
216	16	14.1	16.0	31	46	49	64					
218	18	16.1	18.0	39	55	59	75					
220	20	18.1	20.0	44	62	66	84					

Clamping shank with adapter DIN 1835 form B Guh. no. 6500	Size	Code no.	Dimensions mm				
			d	L	I	D	d1
	106	25,006	6	82	56	54	25
	108	25,008	8				
	110	25,010	10				
	112	25,012	12				
	114	25,014	14				
	214	32,014	14	95	60	63	32
	216	32,016	16				
	218	32,018	18				
	220	32,020	20				

Rotary head 360° Guh. no. 6510	Size	Code no.	Dimensions mm	
			D	
	106-114	54,000	54	
	214-220	63,000	63	
Spare parts				
			V-wedge Guhring no. 6021	Adjusting screw Guhring no. 6022
	Size	Code no.	Code no.	
	106-114	54,000	8,000	
	214-220	63,001	8,000	

Chamfer holder 90° Guh. no. 6520	Size	Code no.	Spare parts clamping screws	
			Guh. no. 6128 Code no.	Insert type
	for all sizes	12,090	2.501	VBM..1102..
		12,120	2.501	DCM..0702..
Chamfer holder 120° Guh. no. 6521				

Clamping bushes

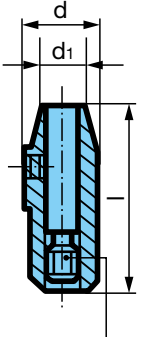
Version	Guhring no.	Code no.*	Dimensions			for centre drills		for step drills	Stop (component) (Spare part Guh. no. 6155)
			d1 mm	d mm	l mm	form A/R drill-Ø	form B drill-Ø		Code no.*
	Guh. no. 6155	4,000	4.0	10.0	32	1.6	–	–	6,000
	for size I	5,000	5.0	10.0	32	2.0	–	–	6,001
		6,300	6.3	10.0	32	2.5	1.6	–	6,002
		Guh. no. 6152	4,000	4.0	20.0	49	1.6	–	–
	for size II	5,000	5.0	20.0	49	2.0	–	–	10,001
		6,300	6.3	20.0	49	2.5	1.6	–	10,002
		8,000	8.0	20.0	49	3.15	2.0	M 4	10,003
		10,000	10.0	20.0	49	4.0	2.5	M 5	10,004
	Guh. no. 6153	6,300	6.3	31.5	70	2.5	1.6	–	12,000
	for size III	8,000	8.0	31.5	70	3.15	2.0	M 4	12,001
		10,000	10.0	31.5	70	4.0	2.5	M 5	12,002
		11,200	11.2	31.5	70	–	3.15	–	12,003
		12,500	12.5	31.5	70	5.0	–	M 6	12,004
		14,000	14.0	31.5	70	–	4.0	M 8	12,005
		16,000	16.0	31.5	70	6.3	–	M 10	12,006
		18,000	18.0	31.5	70	–	5.0	–	12,007

*) When ordering, please always state Guhring no. and code no.!



Guhring no.
Standard
Tool material
Surface
Form
Cutting direction
Discount group

587	588
DIN 333	
HSS	
○	○
A	R
right	right
138	138

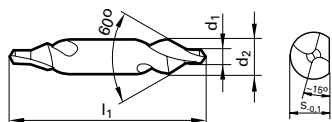

d1	d2	l1	s
mm	mm	mm	mm
1.000	3.150	31.50	2.35
1.600	4.000	35.50	3.25
2.000	5.000	40.00	4.20
2.500	6.300	45.00	5.35
3.150	8.000	50.00	6.95
4.000	10.000	56.00	8.40
5.000	12.500	63.00	10.95
6.300	16.000	71.00	14.00
8.000	20.000	80.00	17.90
10.000	25.000	100.00	22.50

Availability	
	○
●	
●	●
●	
●	●
●	●
●	●
●	●
○	●
●	●



Guhring no.
Standard
Tool material
Surface
Form
Cutting direction
Discount group

589
DIN 333
HSS
○
B
right
138

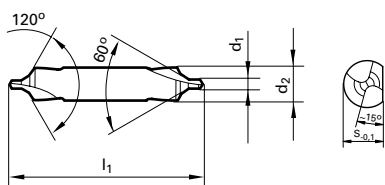

d1	d2	l1	s
mm	mm	mm	mm
1.600	6.300	45.00	5.35
2.000	8.000	50.00	6.95
2.500	10.000	56.00	8.40
3.150	11.200	60.00	10.00
4.000	14.000	67.00	12.65
5.000	18.000	75.00	16.40
6.300	20.000	80.00	17.90
8.000	25.000	100.00	22.50

Availability	
●	
●	
●	
●	
●	
●	
●	

○ bright

● on stock ○ on request

Step drills for centering DIN 332

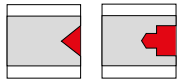

Guhring no.	274	574
Standard	Guhring standard	
Tool material	HSS	
Surface	●	●
Type	N	N
Form	for countersinks form D	for countersinks form DR
Cutting direction	right	right
Discount group	138	138

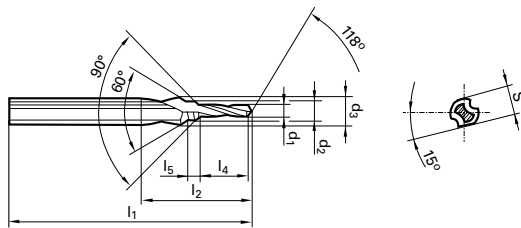

d3 h7	d2	d1 h8	s	l1	l2	l4	l5	for
mm	mm	mm	mm	mm	mm	mm	mm	thread
8.000	4.300	3.300	6.75	63.00	23.00	11.00	1.60	M 4
10.000	5.300	4.200	8.45	67.00	27.00	13.00	2.15	M 5
12.500	6.400	5.000	10.45	71.00	33.00	16.00	2.90	M 6
14.000	8.400	6.800	12.50	88.00	41.00	19.50	3.50	M 8
16.000	10.500	8.500	14.85	94.00	47.00	23.00	4.70	M10
20.000	13.000	10.200	18.45	105.00	59.00	28.00	6.50	M12
25.000	17.000	14.000	23.40	132.00	67.00	33.00	8.30	M16
31.500	21.000	17.500	29.35	145.00	76.50	38.00	10.35	M20
40.000	25.000	21.000	36.50	160.00	90.00	45.00	12.00	M24

Availability	
●	●
●	●
●	●
●	●
●	●
●	●
●	●
●	●
●	●
●	●
●	●
●	●
●	●
●	●
●	●
●	●
●	●
●	●
●	●
●	●
●	●

● steam tempered ● on stock ○ on request

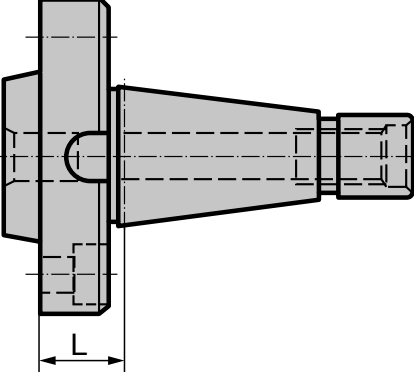
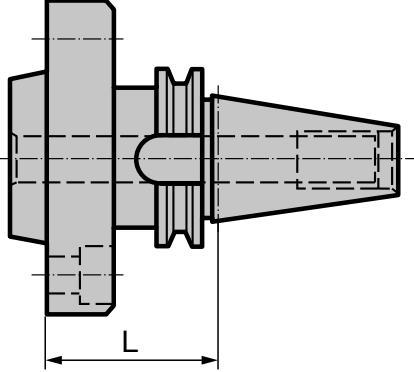
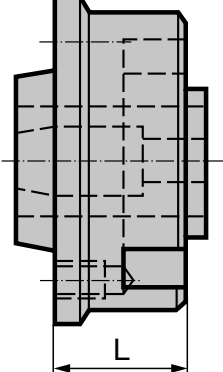
Adaptors with ISO taper to DIN 2080	Code no.*	Size	Tool head size	Interface	Size L mm	Head Ø	
	Guh. no. 6051	30,080	SK 30	II	Ø 30 ^{H6} x 10	16.6	80
		40,080	SK 40	II	Ø 30 ^{H6} x 10	16.6	80
		40,102	SK 40	II	C 3 DIN ISO 702-3	21.6	102
		40,112	SK 40	III	C 4 DIN ISO 702-3	21.6	112
		40,140	SK 40	III	C 5 DIN ISO 702-3	21.6	140
		50,140	SK 50	III	C 5 DIN ISO 702-3	23.2	140
Adaptors with ISO taper to DIN 7388-1 AD	Code no.*	Size	Tool head size	Interface	Size L mm	head Ø	
	Guh. no. 6052	40,102	SK 40	II	C 3 DIN ISO 702-3	55	102
		40,112	SK 40	III	C 4 DIN ISO 702-3	55	112
		40,140	SK 40	III	C 5 DIN ISO 702-3	55	140
		45,112	SK 45	III	C 4 DIN ISO 702-3	55	112
		45,140	SK 45	III	C 5 DIN ISO 702-3	55	140
		50,140	SK 50	III	C 5 DIN ISO 702-3	55	140
Adaptors for UMA Ø 45/88.88	Code no.*	Tool holder adaptors	Tool head size	Interface	Size L mm	Head Ø	
	Guh. no. 6056	3,004	4	II	C 3 DIN ISO 702-3	40	102
		4,002	2	III	C 4 DIN ISO 702-3	40	112
		4,003	3	III	C 4 DIN ISO 702-3	40	112
		4,004	4	III	C 4 DIN ISO 702-3	40	112
		5,004	4	III	C 5 DIN ISO 702-3	45	140

*) When ordering, please always state Guhring no. and code no.! Other systems on request.

Indexable inserts

Indexable insert type	Dimensions of basic body mm				Dimensions of chipbreaker mm		Carbide grade	Surface finish	Cutting direction	Gühring no. Code no.
	R	d	l	s	B	R ₁				
Indexable insert with high radius chipbreaker and 4 cutting edges 	0.0	12.70	12.9	4.76	2.6	1.5	CNHX120400(R/L)226	124,000		
	0.4	12.70	12.9	4.76	2.6	1.5	CNHX120404(R/L)226	124,040		
	0.4	12.70	12.9	4.76	3.0	2.0	CNHX120404(R/L)230	124,041		
	0.8	12.70	12.9	4.76	2.6	1.5	CNHX120408(R/L)226	124,080		
	0.8	12.70	12.9	4.76	3.0	2.0	CNHX120408(R/L)230	124,081		
	0.2	15.88	16.1	6.35	2.6	1.5	CNHX160602(R/L)226	166,000		
	0.4	15.88	16.1	6.35	2.6	1.5	CNHX160604(R/L)226	166,040		
	0.4	15.88	16.1	6.35	2.6	1.5	CNHX160604(R/L)230	166,041		
	0.8	15.88	16.1	6.35	2.6	1.5	CNHX160608(R/L)226	166,080		
	0.8	15.88	16.1	6.35	3.0	1.5	CNHX160608(R/L)230	166,081		
	0.4	19.05	19.3	6.35	3.0	2.0	CNHX190604(R/L)230	196,040		
	0.8	19.05	19.3	6.35	3.0	2.0	CNHX190608(R/L)235	196,080		
	Indexable insert with standard chipbreaker and 4 cutting edges 	0.0	12.70	12.9	4.76	2.2	0.5	CNHX120400(R/L)122	124,000	
0.0		12.70	12.9	4.76	2.6	0.5	CNHX120400(R/L)126	124,001		
0.4		12.70	12.9	4.76	2.2	0.5	CNHX120404(R/L)122	124,040		
0.4		12.70	12.9	4.76	2.6	0.5	CNHX120404(R/L)126	124,041		
0.4		12.70	12.9	4.76	2.6	0.5	CNHX120404(R/L)130	124,042		
0.8		12.70	12.9	4.76	2.6	0.5	CNHX120408(R/L)126	124,080		
0.8		12.70	12.9	4.76	3.0	0.5	CNHX120408(R/L)130	124,081		
0.2		15.88	16.1	6.35	2.6	0.5	CNHX160602(R/L)126	166,000		
0.4		15.88	16.1	6.35	2.6	0.5	CNHX160604(R/L)126	166,040		
0.4		15.88	16.1	6.35	2.6	0.5	CNHX160604(R/L)130	166,041		
0.8		15.88	16.1	6.35	3.0	0.5	CNHX160608(R/L)126	166,080		
0.8		15.88	16.1	6.35	3.0	0.5	CNHX160608(R/L)130	166,081		
0.4		19.05	19.3	6.35	3.0	0.5	CNHX190604(R/L)130	196,040		
Indexable insert with high radius chipbreaker and 2 cutting edges 	0.2	6.35	6.4	2.38	1.2	0.5	CCHX060202(R/L)212	62,020		
	0.4	6.35	6.4	2.38	1.2	0.5	CCHX060204(R/L)212	62,040		
	0.8	6.35	6.4	2.38	1.4	0.5	CCHX060208(R/L)214	62,080		
	0.2	9.53	9.6	3.97	1.6	1.0	CCHX09T302(R/L)216	93,020		
	0.4	9.53	9.6	3.97	1.6	1.0	CCHX09T304(R/L)216	93,040		
	0.8	9.53	9.6	3.97	1.8	1.0	CCHX09T308(R/L)218	93,080		
	0.2	12.70	12.9	4.76	1.6	1.0	CCHX120402(R/L)216	124,020		
	0.4	12.70	12.9	4.76	1.6	1.0	CCHX120404(R/L)216	124,040		
	0.8	12.70	12.9	4.76	1.6	1.0	CCHX120408(R/L)216	124,080		
	Indexable insert without chipbreaker and 2 cutting edges 	0.2	6.35	6.4	2.38	1.2	0.2	CCHX060202(R/L)112	62,020	
0.4		6.35	6.4	2.38	1.2	0.2	CCHX060204(R/L)112	62,040		
0.8		6.35	6.4	2.38	1.4	0.2	CCHX060208(R/L)114	62,080		
0.2		9.53	9.6	3.97	1.6	0.2	CCHX09T302(R/L)116	93,020		
0.4		9.53	9.6	3.97	1.6	0.2	CCHX09T304(R/L)116	93,040		
0.8		9.53	9.6	3.97	1.8	0.2	CCHX09T308(R/L)118	93,080		
0.2		12.90	12.9	4.76	1.6	0.2	CCHX120402(R/L)116	124,020		
0.4		12.90	12.9	4.76	1.6	0.2	CCHX120404(R/L)116	124,040		
0.8		12.90	12.9	4.76	1.6	0.2	CCHX120408(R/L)116	124,080		

○ bright

● S TiN

● A TiAlN

● A AlTiN

● C TiCN

● on stock

○ on request

K10		K10		K10		K10		P40		P40		P40		P40		P40		P40	
○		Ⓢ		Ⓐ		Proton		○		Ⓢ		Ⓐ		Ⓐ		Ⓢ		Proton	
right	left	right	left	right	left	right	left	right	left	right	left	right	left	right	left	right	left	right	left
6208	6252							6211	6255	6212	6256	6213				6214			
Availability																			
●	○							●	○	●	○	●	○			○			
●	○							●	○	●	○	●	○			○			
●	○							●	○	●	○	●	○			○			
●	○							●	○	●	○	●	○			○			
●	○							●	○	●	○	●	○			○			
○	○							○	○	○	○	○	○			○			
○	○							○	○	○	○	○	○			○			
○	○							○	○	○	○	○	○			○			
○	○							○	○	○	○	○	○			○			
○	○							○	○	○	○	○	○			○			
○	○							○	○	○	○	○	○			○			
○	○							○	○	○	○	○	○			○			

K10		K10		K10		K10		P40		P40		P40		P40		P40		P40	
○		Ⓢ		Ⓐ		Proton		○		Ⓢ		Ⓐ		Ⓐ		Ⓢ		Proton	
right	left	right	left	right	left	right	left	right	left	right	left	right	left	right	left	right	left	right	left
6201	6245							6204	6248	6205	6249	6206	6250			6207	6251		
Availability																			
●	○							●	○	●	○	○	○			○	○		
○	○							○	○	○	○	○	○			○	○		
○	○							○	○	○	○	○	○			○	○		
○	○							○	○	○	○	○	○			○	○		
○	○							○	○	○	○	○	○			○	○		
○	○							○	○	○	○	○	○			○	○		
○	○							○	○	○	○	○	○			○	○		
○	○							○	○	○	○	○	○			○	○		
○	○							○	○	○	○	○	○			○	○		
○	○							○	○	○	○	○	○			○	○		
○	○							○	○	○	○	○	○			○	○		

K10		K10		K10		K10		P40		P40		P40		P40		P40		P40	
○		Ⓢ		Ⓐ		Proton		○		Ⓢ		Ⓐ		Ⓐ		Ⓢ		Proton	
right	left	right	left	right	left	right	left	right	left	right	left	right	left	right	left	right	left	right	left
6277	6278	6293	6298			6661	6662	6281	6282	6283	6284					6663	6664		
Availability																			
●	●	●	●			●	●	●	●	●	●					●	●		
●	●	●	●			●	●	●	●	●	●					●	●		
●	●	●	●			●	●	●	●	●	●					●	●		
●	●	●	●			●	●	●	●	●	●					●	●		
●	●	●	●			●	●	●	●	●	●					●	●		
●	●	●	●			●	●	●	●	●	●					●	●		
●	●	●	●			●	●	●	●	●	●					●	●		
●	●	●	●			●	●	●	●	●	●					●	●		
●	●	●	●			●	●	●	●	●	●					●	●		
●	●	●	●			●	●	●	●	●	●					●	●		

K10		K10		K10		K10		P40		P40		P40		P40		P40		P40	
○		Ⓢ		Ⓐ		Proton		○		Ⓢ		Ⓐ		Ⓐ		Ⓢ		Proton	
right	left	right	left	right	left	right	left	right	left	right	left	right	left	right	left	right	left	right	left
6677	6678	6693	6698	6679	6680	6685	6686	6681	6682	6683	6684			6675	6676			6687	6688
Availability																			
●	●	●	●	●	●	●	●	●	●	●	●			●	●			●	●
●	●	●	●	●	●	●	●	●	●	●	●			●	●			●	●
●	●	●	●	●	●	●	●	●	●	●	●			●	●			●	●
●	●	●	●	●	●	●	●	●	●	●	●			●	●			●	●
●	●	●	●	●	●	●	●	●	●	●	●			●	●			●	●
●	●	●	●	●	●	●	●	●	●	●	●			●	●			●	●
●	●	●	●	●	●	●	●	●	●	●	●			●	●			●	●
●	●	●	●	●	●	●	●	●	●	●	●			●	●			●	●
●	●	●	●	●	●	●	●	●	●	●	●			●	●			●	●
●	●	●	●	●	●	●	●	●	●	●	●			●	●			●	●

*) When ordering, please always state ISO code, carbide grade, Guhring no. and code no.!(example: CNHX120400R226 K10 6208 124.000)
Further coatings on request (p. 50)!

Indexable inserts

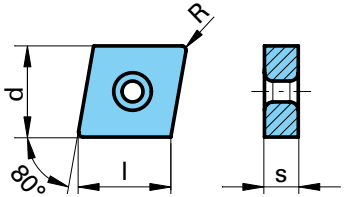
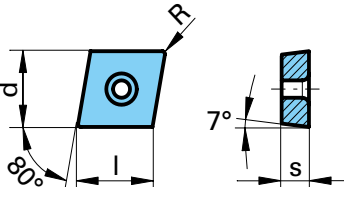
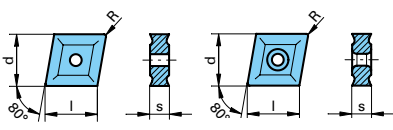
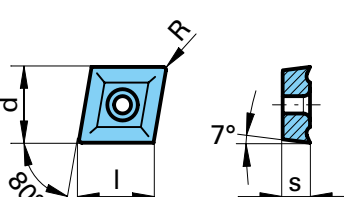
Indexable insert type	Dimensions indexable inserts				Carbide grade	Surface finish	Cutting direction
	mm						
Indexable insert without chipbreaker and 4 cutting edges	R	d	l	s			
	0.0	12.70	12.9	4.76	CNHQ120400N	124,000	
	0.4	12.70	12.9	4.76	CNHQ120404N	124,040	
	0.8	12.70	12.9	4.76	CNHQ120408N	124,080	
	0.2	15.88	16.1	06.35	CNHQ160602N	166,020	
	0.4	15.88	16.1	6.35	CNHQ160604N	166,040	
	0.8	15.88	16.1	6.35	CNHQ160608N	166,080	
	0.4	19.05	19.3	6.35	CNHQ190604N	196,040	
	0.8	19.05	19.3	6.35	CNHQ190608N	196,080	
Indexable insert without chipbreaker and 2 cutting edges	Dimensions indexable inserts				Cutting direction		
	mm				ISO code*	Gühring no. Code no.	
	R	d	l	s			
	0.2	6.35	6.4	2.38	CCHW060202N	62,020	
	0.4	6.35	6.4	2.38	CCHW060204N	62,040	
	0.8	6.35	6.4	2.38	CCHW060208N	62,080	
	0.2	9.53	9.6	3.97	CCHW09T302N	93,020	
	0.4	9.53	9.6	3.97	CCHW09T304N	93,040	
	0.8	9.53	9.6	3.97	CCHW09T308N	93,080	
	0.2	12.70	12.9	4.76	CCHW120402 N	124,020	
	0.4	12.70	12.9	4.76	CCHW120404 N	124,040	
0.8	12.70	12.9	4.76	CCHW120408 N	124,080		
Indexable insert with chipbreaker and 4 cutting edges	Dimensions indexable inserts				Cutting direction		
	mm				ISO code*	Gühring no. Code no.	
	R	d	l	s			
	0.2	12.70	12.9	4.76	CNMU120402N	124,020	
	0.4	12.70	12.9	4.76	CNMG120404N	124,040	
	0.8	12.70	12.9	4.76	CNMG120408N	124,080	
	0.4	15.88	16.1	6.35	CNMU160604N	166,040	
0.8	15.88	16.1	6.35	CNMG160608N	166,080		
Indexable insert with chipbreaker and 2 cutting edges	Dimensions indexable inserts				Cutting direction		
	mm				ISO code*	Gühring no. Code no.	
	R	d	l	s			
	0.2	6.35	6.4	2.38	CCMT060202N	62,020	
	0.4	6.35	6.4	2.38	CCMT060204N	62,040	
	0.6	6.35	6.4	2.38	CCMT060208N	62,080	
	0.2	9.53	9.6	3.97	CCMT09T302N	93,020	
	0.4	9.53	9.6	3.97	CCMT09T304N	93,040	
	0.6	9.53	9.6	3.97	CCMT09T308N	93,080	
	0.4	12.70	12.9	4.76	CCMT120404N	124,040	
	0.6	12.70	12.9	4.76	CCMT120408N	124,080	

○ blank

● S TiN

● on stock



○ on request

	K10	P40	P40	P40
	○ left/right	○ left/right		
	6215	6236		
Availability				
	● ● ●	● ● ●		
	● ● ●	● ● ●		
	● ●	● ●		
	○ left/right	○ neutral		
	6287	6289		
Availability				
	● ● ●	● ● ●		
	● ● ●	● ● ●		
	● ● ●	● ● ●		
	○ left/right	○ left/right	Ⓢ left/right	Ⓢ left/right
	6294	6275	6276	6297
Availability				
	● ●	●	●	● ●
	○			○
	○ left/right		Ⓢ left/right	
	6271		6273	
Availability				
	● ● ●		● ● ●	
	● ● ●		● ● ●	
	● ● ●		● ● ●	

*) When ordering, please always state ISO code, carbide grade, Guhring no. and code no.! (example: CNHX120400R226 K10 6208 124.000)
Further coatings on request (p. 50)!

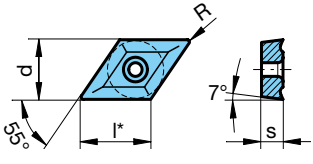
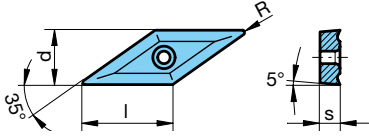
Indexable inserts, and insert blanks

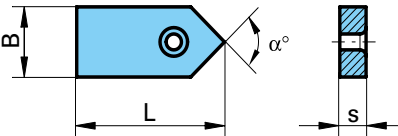
Indexable insert type	Dimensions indexable inserts mm				ISO code*	Carbide grade Surface finish Cutting direction Guhring no. Code no.
Indexable insert with chipbreaker and 2 cutting edges	R	d	l	s	ISO code*	Code no.
		0.2 0.4 0.4	6.35 6.35 9.53	7.8 7.8 11.0		
Indexable insert with chipbreaker and 2 cutting edges	Dimensions indexable inserts mm				ISO code*	Surface finish Cutting direction Guhring no. Code no.
Indexable insert with chipbreaker and 2 cutting edges	R	d	l	s	ISO code*	Code no.
		0.2	6.35	11.0		

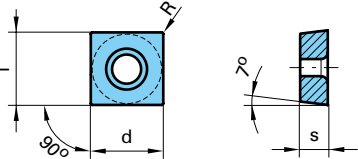
Indexable insert type	Dimensions indexable inserts mm				Clamping screw  Guhring no, 6128	Carbide grade Surface finish Cutting direction Guhring no, Code no,	
Insert blank	B	L	α°	s	Code no,	Drawing no,	Code no,
		6,4 7,4 8,4 9,4 10,4 13,4	13,25 16,70 20,70 18,65 18,70 23,50	90,0 60,0 60,0 90,0 90,0 90,0			
Indexable insert form S without chipbreaker 1 cutting edge	Dimensions indexable inserts mm				Clamping screw  Guhring no, 6128	Surface finish Cutting direction Guhring no, Code no,	
Indexable insert form S without chipbreaker 1 cutting edge	R	d	l	s	Code no,	Drawing no,	Code no,
		0,2 0,4 0,8 0,2 0,4 0,8	9,53 9,53 9,53 12,70 12,70 12,70	9,53 9,53 9,53 4,76 4,76 4,76			

○ bright

● S TiN

● on stock

○ on request

K10		P40	
○		Ⓢ	
left/right		left/right	
6290		6231	
Availability			
●		●	
●		●	
●			
○		Ⓢ	
left/right		left/right	
6291		6292	
Availability			
●		●	

K10		P40	
○		○	
left/right		left/right	
6285		6286	
Availability			
●		●	
●		●	
●		●	
●		●	
●		●	
●		●	
○		○	
left/right		left/right	
6300		6350	
Availability			
●		●	
●		●	
●		●	
●		●	
●		●	
●		●	

*) When ordering, please always state ISO code, carbide grade, Guhring no. and code no.! (example: CNHX120400R226 K10 6208 124.000)
 Further coatings on request (p. 50)!

Indexable insert ISO

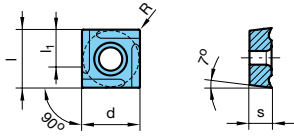
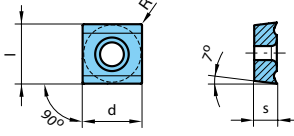
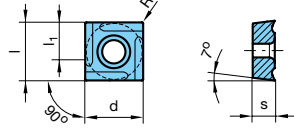
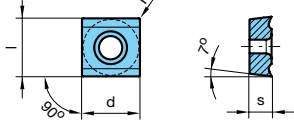
Indexable insert type	Dimensions Indexable insert mm					Clamping screw  Guhring no. 6128	Carbide grade	Surface finish	Cutting direction
	R	d	l	s	l ₁	Code no.	ISO code*	Guhring no. Code no.	
Indexable insert form S with chipbreaker 10° 	0.2	9.53	9.53	3.97	4.0	3.501	SCHX 09T302 (R/L) 116	93,020	
	0.4	9.53	9.53	3.97	4.0	3.501	SCHX 09T304 (R/L) 116	93,040	
	0.8	9.53	9.53	3.97	4.0	3.501	SCHX 09T308 (R/L) 118	93,080	
	0.2	12.70	12.70	4.76	5.0	4.000	SCHX 120402 (R/L) 126	124,020	
	0.4	12.70	12.70	4.76	5.0	4.000	SCHX 120404 (R/L) 126	124,040	
	0.8	12.70	12.70	4.76	5.0	4.000	SCHX 120408 (R/L) 126	124,080	
	Indexable insert form S with chipbreaker 10° 2 cutting edges 	0.2	9.53	9.53	3.97		3.501	SCHX 09T302 N 116	93,020
		0.4	9.53	9.53	3.97		3.501	SCHX 09T304 N 116	93,040
		0.8	9.53	9.53	3.97		3.501	SCHX 09T308 N 118	93,080
0.2		12.70	12.70	4.76		4.000	SCHX 120402 N 126	124,020	
0.4		12.70	12.70	4.76		4.000	SCHX 120404 N 126	124,040	
0.8		12.70	12.70	4.76		4.000	SCHX 120408 N 126	124,080	
Indexable insert form S with chipbreaker 18° 		0.2	9.53	9.53	3.97	4.0	3.501	SCHX 09T302 (R/L) 216	93,020
		0.4	9.53	9.53	3.97	4.0	3.501	SCHX 09T304 (R/L) 216	93,040
		0.8	9.53	9.53	3.97	4.0	3.501	SCHX 09T308 (R/L) 218	93,080
	0.2	12.70	12.70	4.76	5.0	4.000	SCHX 120402 (R/L) 226	124,020	
	0.4	12.70	12.70	4.76	5.0	4.000	SCHX 120404 (R/L) 226	124,040	
	0.8	12.70	12.70	4.76	5.0	4.000	SCHX 120408 (R/L) 226	124,080	
	Indexable insert form S with chipbreaker 18° 2 cutting edges 	0.2	9.53	9.53	3.97		3.501	SCHX 09T302 N 216	93,020
		0.4	9.53	9.53	3.97		3.501	SCHX 09T304 N 216	93,040
		0.8	9.53	9.53	3.97		3.501	SCHX 09T308 N 218	93,080
0.2		12.70	12.70	4.76		4.000	SCHX 120402 N 226	124,020	
0.4		12.70	12.70	4.76		4.000	SCHX 120404 N 226	124,040	
0.8		12.70	12.70	4.76		4.000	SCHX 120408 N 226	124,080	

○ bright

● S TiN

● A AlTiN







● on stock

○ on request

K10		K10		K10		K10		P40		P40		P40		P40	
○ right	○ left	Ⓢ right	Ⓢ left	Ⓐ right	Ⓐ left	Proton right left		○ right	○ left	Ⓢ right	Ⓢ left	Ⓐ right	Ⓐ left	Proton right left	
6304	6306	6315	6317	6325	6327	6335	6337	6354	6356	6365	6367	6375	6377	6385	6387
Availability															
●	●	●	●	●	●	●	●	●	●	●	●	●	●	●	●
●	●	●	●	●	●	●	●	●	●	●	●	●	●	●	●
●	●	●	●	●	●	●	●	●	●	●	●	●	●	●	●
●	●	●	●	●	●	●	●	●	●	●	●	●	●	●	●
●	●	●	●	●	●	●	●	●	●	●	●	●	●	●	●
○ left/right	Ⓢ left/right	Ⓐ left/right	Proton left/right		○ left/right	Ⓢ left/right	Ⓐ left/right	Proton left/right							
6302	6313	6323	6333	6352	6363	6373	6383								
Availability															
●	●	●	●	●	●	●	●								
●	●	●	●	●	●	●	●								
●	●	●	●	●	●	●	●								
●	●	●	●	●	●	●	●								
●	●	●	●	●	●	●	●								
○ right	○ left	Ⓢ right	Ⓢ left	Ⓐ right	Ⓐ left	Proton right left		○ right	○ left	Ⓢ right	Ⓢ left	Ⓐ right	Ⓐ left	Proton right left	
6303	6305	6314	6316	6324	6326	6334	6336	6353	6355	6364	6366	6374	6376	6384	6386
Availability															
●	●	●	●	●	●	●	●	●	●	●	●	●	●	●	●
●	●	●	●	●	●	●	●	●	●	●	●	●	●	●	●
●	●	●	●	●	●	●	●	●	●	●	●	●	●	●	●
●	●	●	●	●	●	●	●	●	●	●	●	●	●	●	●
●	●	●	●	●	●	●	●	●	●	●	●	●	●	●	●
○ left/right	Ⓢ left/right	Ⓐ left/right	Proton left/right		○ left/right	Ⓢ left/right	Ⓐ left/right	Proton left/right							
6301	6312	6322	6332	6351	6362	6372	6382								
Availability															
●	●	●	●	●	●	●	●								
●	●	●	●	●	●	●	●								
●	●	●	●	●	●	●	●								
●	●	●	●	●	●	●	●								
●	●	●	●	●	●	●	●								

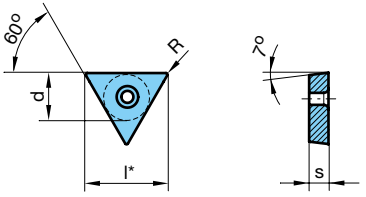
*) When ordering, please always state ISO code, carbide grade, Guhring no. and code no.! (example: CNHX120400R226 K10 6208 124.000)
Further coatings on request (p. 50)!

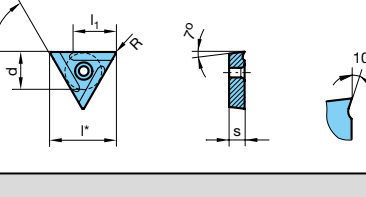
Indexable insert ISO

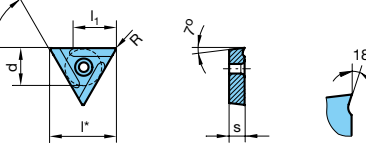
Indexable insert type	Dimensions indexable inserts mm					Clamping screw  Guhring no. 6128	Carbide grade	Surface finish	Cutting direction
	R	d	l*	s		Code no.	Drawing no.	Guhring no.	Code no.
Indexable insert form T without chipbreaker						 Guhring no. 6128			
l* theoretical cutting point	0.2	6.35	11.0	2.38		2,501	TCHW 110202 N		112,020
	0.4	6.35	11.0	2.38		2,501	TCHW 110204 N		112,040
	0.8	6.35	11.0	2.38		2,501	TCHW 110208 N		112,060
	0.2	9.53	16.5	3.97		3,501	TCHW 16T302 N		163,020
	0.4	9.53	16.5	3.97		3,501	TCHW 16T304 N		163,040
	0.8	9.53	16.5	3.97		3,501	SCHW 16T308 N		163,080
Indexable insert form T with chipbreaker 10° 2 cutting edges						 Guhring no. 6128			
l* theoretical cutting point	0.2	6.35	11.0	2.38	6.0	2,501	TCHX 110202 (R/L) 112		112,020
	0.4	6.35	11.0	2.38	6.0	2,501	TCHX 110204 (R/L) 112		112,040
	0.8	6.35	11.0	2.38	6.0	2,501	TCHX 110208 (R/L) 114		112,080
	0.2	9.53	16.5	3.97	9.5	3,501	TCHX 16T302 (R/L) 116		163,020
	0.4	9.53	16.5	3.97	9.5	3,501	TCHX 16T304 (R/L) 116		163,040
	0.8	9.53	16.5	3.97	9.5	3,501	TCHX 16T308 (R/L) 118		163,080
WSP form T with chipbreaker 18° 2 cutting edges						 Guhring no. 6128			
l* theoretical cutting point	0.2	6.35	11.0	2.38	6.0	2,501	TCHX 110202 (R/L) 212		112,020
	0.4	6.35	11.0	2.38	6.0	2,501	TCHX 110204 (R/L) 212		112,040
	0.8	6.35	11.0	2.38	6.0	2,501	TCHX 110208 (R/L) 214		112,080
	0.2	9.53	16.5	3.97	9.5	3,501	TCHX 16T302 (R/L) 216		163,020
	0.4	9.53	16.5	3.97	9.5	3,501	TCHX 16T304 (R/L) 216		163,040
	0.8	9.53	16.5	3.97	9.5	3,501	TCHX 16T308 (R/L) 218		163,080

○ bright

● S TiN

● A AlTiN

● on stock

○ on request

K10		K10		K10		K10		P40		P40		P40		P40	
○ left/right								○ left/right							
6307								6357							
Availability															
●								●							
●								●							
●								●							
●								●							
●								●							
○		S		A		Proton		○		S		A		Proton	
right	left	right	left	right	left	right	left	right	left	right	left	right	left	right	left
6309	6311	6319	6321	6329	6331	6339	6341	6359	6361	6369	6371	6379	6381	6389	6391
Availability															
●		●		●		●		●		●		●		●	
●		●		●		●		●		●		●		●	
●		●		●		●		●		●		●		●	
●		●		●		●		●		●		●		●	
●		●		●		●		●		●		●		●	
●		●		●		●		●		●		●		●	
○		S		A		Proton		○		S		A		Proton	
right	left	right	left	right	left	right	left	right	left	right	left	right	left	right	left
6308	6310	6318	6320	6328	6330	6338	6340	6358	6360	6368	6370	6378	6380	6388	6390
Availability															
●		●		●		●		●		●		●		●	
●		●		●		●		●		●		●		●	
●		●		●		●		●		●		●		●	
●		●		●		●		●		●		●		●	
●		●		●		●		●		●		●		●	
●		●		●		●		●		●		●		●	

*) When ordering, please always state ISO code, carbide grade, Guhring no. and code no.! (example: CNHX120400R226 K10 6208 124.000)
 Further coatings on request (p. 50)!

Indexable insert description to DIN ISO 1832:2005-11

Insert form			Clearance angle		Tolerance				Insert type		Insert size / I/C diameter / edge									
De-scription	Angle	Form	De-scription	Angle	Tolerance class in relation to inscribed circle			Limit dimensions			De-scription	form	Size	form	C	D	E	H	M	O
					A	C	D	d ± mm	m ± mm	s ± mm										
A	85°		A	3°	A	-	0.025	0.005	0.025	A		03	I/C edge l. x)				6.350 3.666		7.938 3.288	
B	82°		B	5°	C	-	0.025	0.013	0.025	B		04	I/C edge l. x)	4.760 4.833	3.970 4.853	4.760 4.928	7.938 4.583	4.760 4.772	9.53 3.945	
C	80°				D	-	0.010	0.010	0.010	C		05	I/C edge l. x)	5.560 5.646	4.760 5.811	5.560 5.756	9.53 5.499	5.560 5.574	12.700 5.261	
D	55°		C	7°	E	-	0.025	0.025	0.025	F		06	I/C edge l. x)	6.350 6.448	5.560 6.788	6.350 6.574		6.350 6.366	15.875 6.576	
E	75°				F	-	0.013	0.005	0.025	G		07	I/C edge l. x)		6.350 7.752		12.700 7.332	7.938 7.957	19.050 7.891	
H	120°				G	-	0.025	0.025	0.130	H		08	I/C edge l. x)	7.938 8.060		7.938 8.218				
K	55°		E	20°	H	-	0.013	0.013	0.025	J		09	I/C edge l. x)	9.53 9.672	7.938 9.691	9.53 9.861	15.875 9.165	9.53 9.548		
L	90°				J	4.76 - 9.25 12.7 15.875-19.05 25.4	0.050 0.080 0.100 0.130	0.005	0.025	M		10	I/C edge l. x)						25.400 10.521	
M	86°		F	25°	K	4.76 - 9.25 12.7 15.875-19.05 25.4	0.050 0.080 0.100 0.130	0.013	0.025	N		11	I/C edge l. x)		9.53 11.628		19.050 10.999			
O	135°				L	4.76 - 9.25 12.7 15.875-19.05 25.4	0.050 0.080 0.100 0.130	0.025	0.025	Q		12	I/C edge l. x)	12.700 12.896				12.700 12.731		
P	108°		G	30°	M	4.76 - 9.25 12.7 15.875-19.05 25.4	0.050 0.080 0.100 0.130	0.080 0.130 0.150 0.180	0.130	R		13	I/C edge l. x)			12.700 13.148			31.75 13.151	
R					N	(not form D+V see exceptions)	4.76 - 9.25 12.7 15.875-19.05 25.4	0.050 0.080 0.100 0.130	0.080 0.130 0.150 0.180	0.025	T		15	I/C edge l. x)		12.700 15.504			15.875 15.914	
S	90°		P	11°	N	(not form D+V see exceptions)	4.76 - 9.25 12.7 15.875-19.05 25.4	0.050 0.080 0.100 0.130	0.080 0.130 0.150 0.180	0.025	U		16	I/C edge l. x)	15.875 16.120		15.875 16.435			
T	60°				U	4.76 - 9.25 12.7 15.875-19.05 25.4	0.080 0.130 0.180 0.250	0.130 0.200 0.270 0.380	0.130	W		17	I/C edge l. x)							
V	35°		O	others	X					X		19	I/C edge l. x)	19.050 19.826	15.875 19.380	19.050 19.722		19.050 19.097		
W	80°																			
C			C		G				W		09									

Exceptions

M+N form D	4.76 - 9.25 12.7 15.875-19.05 25.4	0.050 0.080 0.100 -	0.110	as above
M+N form V	6.35 7.94 9.53	0.050	0.160	as above

x) mathematical, theoretical value for a corner radius of 0.00 mm see also DIN 4988

Hole diameter/countersink diameter			
Diameter	Indexable insert with countersink (40° - 60°) to DIN/ISO 6987 insert type Q, T, W		Indexable insert with cylindrical hole to DIN 4988 insert type A, G, M
	d1	d2	d1
4.760	2.150	2.700	-
5.560	2.500	3.300	-
6.000	2.800	3.750	-
6.350	2.800	3.750	2.260
7.940	3.400	4.500	-
8.000	3.400	4.500	-
9.525	4.400	6.000	3.810
10.000	4.400	6.000	-
12.000	4.400	6.000	-
12.700	5.500	7.500	5.160
15.875	5.500	7.500	6.350
16.000	5.500	7.500	-
19.050	6.500	9.000	7.940
20.000	6.500	9.000	-
25.000	8.600	12.000	-
25.400	8.600	12.000	9.120

length					
P	R	S	T	V	W
					5.560 2.716
6.350 4.614		4.760 4.760			6.350 4.344
7.938 5.765		5.560 5.560			7.938 5.430
9.53 6.920	6.350 6.00*)	6.350 6.350	3.970 6.876	3.970 6.921	9.53 6.515
	7.938	7.938 7.938			
	8.00*)		4.760 8.245	4.760 8.299	12.700 8.687
12.700 9.227	9.53	9.53 9.53	5.560 9.630	5.560 9.694	
	10.00*)				15.875 10.859
15.875 11.534			6.350 10.999	6.350 11.071	
	12.700 12.00*)	12.700 12.700			
19.050 13.841			7.938 13.749	7.938 13.839	19.050 13.031
	15.875	15.875 15.875			
	16.00*)		9.53 16.498	9.53 16.606	
					25.400 17.375
	19.050	19.050 19.050			

Insert thickness	
Description	s mm
01	1.59
T1	1.98
02	2.38
03	3.18
T3	3.97
04	4.76
05	5.56
06	6.35
07	7.94
09	9.52
12	12.7

Cutting edge corner	
Description	Radius mm
00	sharp point / indication for round insert inch
M0	Indication for round insert metric
02	0.2
04	0.4
08	0.8
12	1.2
16	1.6
20	2.0

Cutting edge corner design	
Description	form
F	sharp
E	rounded
T	chamfered
S	chamfered + rounded
K	double chamfered
P	double chamfered + rounded

Cutting direction	
Description	form
R	right-hand
L	left-hand
N	neutral

Fitting form	
Corner fitting (choice) S = short cutting edge	
AS	1 corner on one side e.g. C insert (1 cutting edge)
BS	2 corners on one side e.g. V insert (2 cutting edges)
CS	3 corners on one side e.g. T insert (3 cutting edges)
DS	4 corners on one side e.g. S insert (4 cutting edges)
KS	1 corner on two sides e.g. C insert (2 cutting edges)
LS	2 corners on two sides e.g. D insert (4 cutting edges)
MS	3 corners on two sides e.g. T insert (6 cutting edges)
NS	4 corners on two sides e.g. S insert (8 cutting edges)
Shank fitting (choice) L = long cutting edge	
AL	One cutting edge along the entire length
Entire surface	
S	Solid
F	Full-face

T3

04

F

R

AS

*) = Size to ISO 1832:2005-11 table A.2.
Round cutting inserts "metric" design.
Distinction see column cutting edge corner
(M0 = metric, 00 = inch)

Planar chamfer	
Setting angle K_r of main cutting edge in feed direction	Clearance angle of planar chamfer
A 45°	A 3°
D 60°	B 5°
E 75°	C 7°
F 85°	D 15°
P 90°	E 20°
Z *	F 25°
	G 30°
	N 0°
	P 11°
	Z *

*Special design

Note:
Overview is for information only.
No liability is accepted for the correctness of the contents. Is not subject to modification.
Definitive data can be found in the respective standards.

Indexable insert description to ANSI (inch dimensions)

Insert form			Clearance angle		Tolerance				Insert type		Insert size /						
Description	Angle	form	Description	Angle	Tolerance class	Limit dim. (inch/mm)			Description	form	Size	IC		C	D	E	H
						B±	A±	T±				inch	mm				
A	8°		A	3°	A	0.0002" 0.005	0.0010" 0.025	0.0010" 0.025	A		1.25	5/32"	3.969	4.030	4.845	4.109	2.292
B	82°		B	5°	B	0.0002" 0.005	0.0010" 0.025	0.0050" 0.125	B		1.5	3/16"	4.763	4.836	5.815	4.931	2.750
C	80°		C	7°	C	0.0005" 0.013	0.0010" 0.025	0.0010" 0.025	C		1.75	7/32"	5.556	5.642	6.783	5.752	3.208
D	55°		D	15°	D	0.0005" 0.013	0.0010" 0.025	0.0050" 0.125	F		2	1/4"	6.350	6.448	7.752	6.574	3.666
E	75°		E	20°	E	0.0010" 0.025	0.0010" 0.025	0.0010" 0.025	G		2.5	5/16"	7.938	8.060	9.691	8.218	4.583
H	120°		F	25°	F	0.0002" 0.005	0.0005" 0.013	0.0010" 0.025	H		3	3/8"	9.53	9.672	11.628	9.861	5.499
K	55°		G	30°	G	0.0010" 0.025	0.0010" 0.025	0.0050" 0.125	J		4	1/2"	12.700	12.896	15.504	13.148	7.332
L	90°		N	0°	H	0.0005" 0.013	0.0005" 0.013	0.0010" 0.025	K		5	5/8"	15.875	16.120	19.380	16.435	9.165
M	86°		P	11°	J	0.0002" 0.005	*	0.0010" 0.025	L		6	3/4"	19.050	19.826	23.256	19.722	10.999
O	135°		O	other	M	*	*	0.0050" 0.125	M		8	1"	25.400	24.878	29.909	25.364	14.145
P	108°				N	*	*	0.0010" 0.025	N		10	1 1/4"	31.750	32.240	38.760	32.870	18.331
R	90°				U	*	*	0.0050" 0.125	Q								
S	90°				X	Special design			R								
T	60°								T								
V	35°								U								
W	80°								W								
C			C		G				W								

Edge length in mm

Extended tolerance specifications *

Insert form	Clear.-angle	Tolerance	3/16"	7/32"	1/4"	5/16"	3/8"	1/2"	5/8"	3/4"	1"	1"
C, E, H, M, O, P, S, T, R, W	A	J, K, L, M, N	0.002" 0.051	0.002" 0.051	0.002" 0.051	0.002" 0.051	0.002" 0.051	0.003" 0.076	0.004" 0.102	0.004" 0.102	0.005" 0.127	0.006" 0.152
		U	0.003" 0.076	0.003" 0.076	0.003" 0.076	0.003" 0.076	0.003" 0.076	0.005" 0.127	0.007" 0.178	0.007" 0.178	0.010" 0.254	0.010" 0.254
	B	M, N	0.003" 0.076	0.003" 0.076	0.003" 0.076	0.003" 0.076	0.003" 0.076	0.005" 0.127	0.006" 0.152	0.006" 0.152	0.007" 0.178	0.008" 0.203
		U	0.005" 0.127	0.005" 0.127	0.005" 0.127	0.005" 0.127	0.005" 0.127	0.008" 0.203	0.011" 0.279	0.011" 0.279	0.015" 0.381	0.015" 0.381
D	A	J, K, L, M, N, U	0.002" 0.051	0.002" 0.051	0.002" 0.051	0.002" 0.051	0.002" 0.051	0.003" 0.076	0.004" 0.102	0.004" 0.102	0.004" 0.102	0.004" 0.102
	B	M, N, U	0.004" 0.102	0.004" 0.102	0.004" 0.102	0.004" 0.102	0.004" 0.102	0.006" 0.152	0.007" 0.178	0.007" 0.178	0.007" 0.178	0.007" 0.178

I/C diameter / edge length							
M	O	P	R	S	T	V	W
3.979	1.644	2.884	3.969	3.969	6.875	6.920	2.715
4.775	1.973	3.461	4.763	4.763	8.250	8.304	3.258
5.570	2.301	4.037	5.556	5.556	9.623	9.687	3.801
6.366	2.630	4.614	6.350	6.350	10.999	11.071	4.344
7.957	3.288	5.765	7.938	7.938	13.749	13.839	5.430
9.548	3.945	6.920	9.53	9.53	16.498	16.606	6.515
12.731	5.261	9.227	12.700	12.700	21.997	22.142	8.687
15.914	6.576	11.534	15.875	15.875	27.496	27.677	10.859
19.097	7.891	13.841	19.050	19.050	19.050	32.996	13.031
24.560	10.148	17.800	25.400	25.400	42.435	42.714	17.375
31.828	13.151	23.068	31.750	31.750	54.993	55.354	21.718
4							

Insert thickness		
Description	s inch	s mm
1	1/16"	1.59
1.2	5/64"	1.98
1.5	3/32"	2.38
2	1/8"	3.175
2.5	5/32"	3.97
3	3/16"	4.763
3.5	7/32"	5.56
4	1/4"	6.35
5	5/16"	7.938
6	3/8"	9.53
3		

Cutting edge corner		
Description	Radius inch	Radius mm
0	0"	0
0.2	0.004"	0.102
0.5	0.008"	0.203
1	1/64"	0.397
2	1/32"	0.798
3	3/64"	1.191
4	1/16"	1.588
5	5/64"	1.984
6	3/32"	2.381
7	7/64"	2.778
8	1/8"	3.175
1		

Cutting direction	
Description	form
R	
L	
N	
R	

Cutt. edge corner design	
Description	form
F	
E	
T	
S	
K	
P	
F	

Comparison insert thickness		
Descr. ANSI	Descr. ISO	s mm
1	01	1.59
1.2	T1	1.98
1.5	02	2.38
2	03	3.18
2.5	T3	3.97
3	04	4.76
3.5	06	5.56
4	05	6.35
5	07	7.94

Comparison ANSI ISO - Radius		
Descr. ANSI	Descr. ISO	Radius mm
0	00	0
0.5	02	0.2
1	04	0.4
2	08	0.8
3	12	1.2
4	16	1.6
5	20	2.0
6	24	2.4
7	28	2.8

Surface refining processes, coating

Besides the selection of the optimum tool material and geometry, the tool can be adapted further to the respective machining task by various surface technology processes. Regarding this, Guhring differentiates the following options:

Bright: ○

Our high speed steel or own carbide produced tools provide good basic characteristics for the machining of different materials.





Steam tempered / nitrided / nitrided lands surface finish: ●●●

Steam tempering chemically modifies the peripheral zones of steel surfaces in the µm-range, generating a crystalline iron oxide coating 3-10 µm. These surface finishes improve the tribological characteristics of the tools. Thanks to this surface treatment, the lubricant / coolant adheres better to the tool. This process is generally applied for the machining of carbon steels, that at low cutting speeds tends to create built up edges and cold welding. Additional nitriding of bright tools ensures the dispersion of nitrogen increasing the surface hardness making abrasive applications possible.



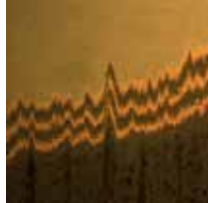

Hard material coatings:

Only 1 to 10 µm thin hard material coatings excel thanks to high hardness, low friction coefficients as well as a high thermo-chemical resistance. Their composition is made-to-measure for the respective application task and the material to be machined.

Overview of the main Guhring coatings

	TiN	TiCN	TiAlN	FIRE/nano FIRE	TiAlN SuperA/nanoA
					
Colour	golden yellow	grey violet	blue violet	violet	blue anthracite
Hardness HV [0.05]	2300	3000	3200	3300	3400
Friction coefficient	0.5 ¹	0.4 ¹	0.55 ¹	0.6 ¹	0.6 ¹
max. application temperature [°C]	< 600	< 400	< 800	< 800	< 900
Brief description	Cost-efficient standard coating	Tough hard coating	Hard coating for abrasive applications, HPC and MQL	Wear-resistant multi-layer coating, also for MQL	Hard coating for difficult and hard machining, HPC as well as MQL

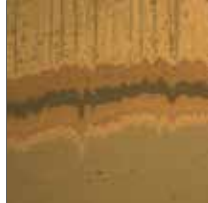
Special coatings

	Signum	Carbo	Cristall	Zenit	ICE
					
Colour	bronze	black	anthracite	pale gold	grey metallic
Hardness HV [0.05]	5500	> 5000	> 8000	2500	3500
Friction coefficient	0.55 ¹	< 0.1 ²	< 0.1 ²	0.4 ¹	0.6 ¹
max. application temperature [°C]	< 800	< 700	< 700	< 800	< 1000
Brief description	Extremely hard, heat-resistant multi-layer coating	Extremely hard coating	Extremely hard diamond coating	nanostructured multi-layer coating for titanium-, aluminium-, nickel-based alloys	Hard, high heat-resistant coating

¹ .. against steel ² .. against aluminium

Cutting material grade	Carbide grade	Coating	Colour	Coating structure	Coating hardness	Application range
K10	K10	uncoated	-	-	-	aluminium and cast materials
K10-S	K10	TiN	golden yellow	single-layer	2300 HV	universal
K10-O	K10	AlTiN	blue anthracite	single-layer	3400 HV	HSC machining
K10-Proton	K10	TiAlN	blue violet	multi-layer	3200 HV	cast materials
K20-A	K20	TiAlN	blue violet	single-layer	3200 HV	universal
P10	P10	uncoated	-	-	-	unalloyed steels
P40	P40	uncoated	-	-	-	unalloyed steels
P40-S	P40	TiN	golden yellow	single-layer	2300 HV	steel materials
P40-O	P40	AlTiN	blue anthracite	single-layer	3400 HV	steel materials
P40-Proton	P40	TiAlN	blue violet	multi-layer	3200 HV	steel and cast materials

Application recommendations for inserts

Guide values for surface finish

In order to select the right feedrate per tooth (fz) please pay also attention to the table below „Guide values for surface finish“. Wiper geometries lead in many cases to better surface finish and higher feed rates along with a constant high accuracy.

Guide values for surface finish relative to feedrate and corner radius

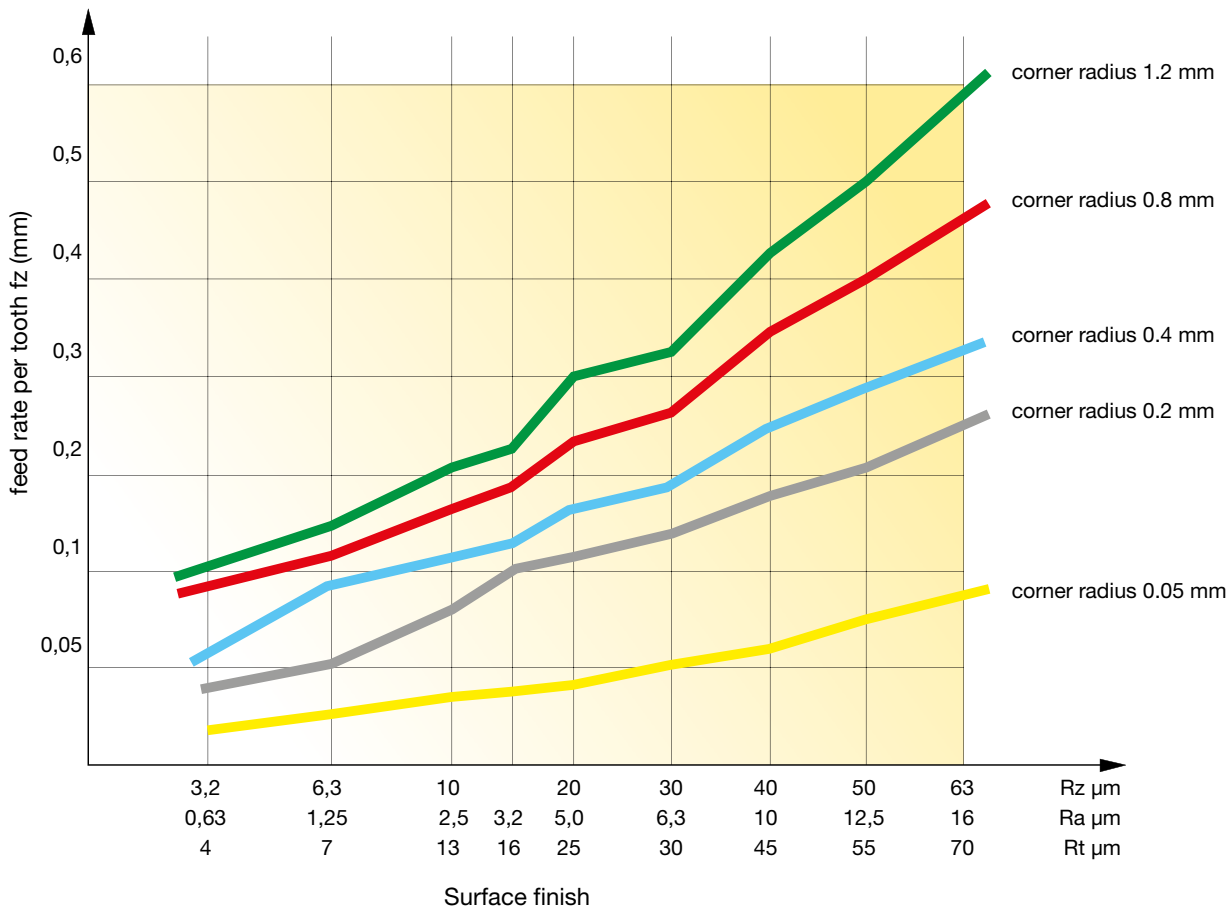

Cutting recommendations for inserts

Cutting groups	Material groups	Composition / Structure	Tensile strength RM (MPa)	Hardness HB HRC	K10 	K10 	K10 	K10 Proton	K20 	
1.1	unalloyed steel	C=0.1 -0.25 annealed, long chip.	420	125	-	-	-	-	120 - 180	
1.2		C=0.1 -0.25 annealed, short chip.	420	125					120 - 180	
2.1		C=0.25 -0.55 annealed, long chip.	620	190					120 - 180	
2.2		Cast steel	C=0.25 -0.55 annealed, short chip.	640					190	120 - 180
3		Machining steel	C=0.25 -0.55 tempered	850					250	120 - 180
4	Machining steel	C=0.25 -0.8 annealed	915	270	-	-	-	-	120 - 180	
5		C=0.25 -0.8 tempered	1020	300					120 - 180	
6		Low-alloy steel	annealed	610					180	90 - 140
7	Cast steel	tempered	930	275	-	-	-	-	90 - 140	
8	Machining steel	tempered	1020	300	-	-	-	-	90 - 140	
9	Machining steel	tempered	1190	350	-	-	-	-	90 - 140	
10	High-alloy steel	annealed	680	200	-	-	-	-	70 - 110	
11	Cast steel									
11	High-alloy tool steel	hardened and tempered	1100	325	-	-	-	-	70 - 110	
12 - 13	Stainless steel and cast steel	ferritic/martensitic annealed	680	200	-	-	-	-	60 - 90	
		martensitic	810	240	-	-	-	-	60 - 90	
14.1	Stainless steel	austenitic quenched	610	180	-	40 - 60	40 - 80	40 - 80	80 - 220	
14.2		austenitic/ferritic (duplex)	880	260	-	40 - 60	40 - 80	40 - 80	80 - 220	
15	Grey cast iron	perlitic/ferritic		180	80 - 140	80 - 140	100 - 200	100 - 200	60 - 200	
16		perlitic (martensitic)		260	80 - 140	80 - 140	100 - 200	100 - 150	60 - 200	
17	Cast iron with nodular cast iron	ferritic		160	60 - 100	80 - 120	80 - 140	80 - 140	100 - 170	
18		perlitic		250	60 - 100	80 - 120	80 - 140	80 - 140	100 - 170	
19	Malleable cast	ferritic		130	-	60 - 120	80 - 140	80 - 140	60 - 100	
20		perlitic		230	-	60 - 120	80 - 140	80 - 140	60 - 100	
21	Aluminium	not heat treatable		60	80 - 400	100 - 500	-	-	-	
22	Forging alloys	heat treatable/ heat treated		100	80 - 400	100 - 500	-	-	-	
23	Aluminium Casting alloys	<12% Si not heat treatable		75	80 - 400	100 - 500	-	-	-	
24		<12% Si heat treatable/ heat treated		90	80 - 400	100 - 500	-	-	-	
25		>12% Si not heat treatable		130	80 - 400	100 - 500	-	-	-	
26	Copper	machined alloys, Pb>1%		110	80 - 300	100 - 300	-	-	-	
27	Copper alloys	CuZn. CuSnZn		90	80 - 300	100 - 300	-	-	-	
28	(bronze, brass)	Cu lead free copper/electrolyte copper		100	80 - 300	100 - 300	-	-	-	
29	Non metallic materials	Duroplastic		-	-	-	-	-	-	
30		Reinforced materials		-	-	-	-	-	-	
31	Heat resistant alloys	Fe-based annealed		200	-	30 - 80	30 - 90	30 - 100	40 - 100	
32		heat treated		230	-	30 - 80	30 - 90	30 - 100	40 - 100	
33		Ni- or Co-based annealed		250	-	30 - 80	30 - 90	30 - 100	40 - 100	
34		heat treated		350	-	30 - 80	30 - 90	30 - 100	40 - 100	
35		cast		320	-	30 - 80	30 - 90	30 - 100	40 - 100	
36	Titanium alloys	Pure titanium		400	-	-	-	-	40 - 100	
37		Alpha-beta alloys		1050	-	-	-	-	40 - 100	
38	Hardened steels			50 - 62	-	-	-	-	-	
39				50 - 62	-	-	-	-	-	

t = dry machining
n = wet machining

 bright

 TiN

 TiAlN

 AlTiN

 TiCN

Cutting speed v_c in m/min

P10 ○	P10 ○	P40 S	P40 A	P40 Proton	CBN 1023	CBN 1024	CBN 1026	CBN 2026	CBN 2028	CBN 3018	PKD Mittelkorn
80 - 120	60 - 100	100 - 140	120 - 160	100 - 160							
80 - 120	60 - 100	100 - 140	120 - 160	100 - 160							
80 - 120	60 - 100	100 - 140	120 - 160	90 - 150							
80 - 120	60 - 100	100 - 140	120 - 160	100 - 160	-	-	-	-	-	-	-
80 - 120	60 - 100	100 - 140	120 - 160	90 - 150							
80 - 120	60 - 100	100 - 140	120 - 160	80 - 140							
80 - 120	60 - 100	100 - 140	120 - 160	75 - 120							
-	-	90 - 130	60 - 100	90 - 140							
-	-	90 - 130	60 - 100	60 - 110	-	-	-	-	-	-	-
-	-	90 - 130	60 - 100	60 - 110							
-	-	90 - 130	60 - 100	60 - 110							
-	-	60 - 100	60 - 100	60 - 110	-	-	-	-	-	-	-
-	-	60 - 100	60 - 100	50 - 90							
-	-	40 - 80	40 - 80	40 - 90	-	-	-	-	-	-	-
-	-	40 - 80	40 - 80	40 - 90							
-	-	-	-	-	-	-	-	-	-	-	-
-	-	-	-	-	200 - 600	200 - 600	200 - 600	200 - 600	200 - 600	750 - 1100 t	-
-	-	-	-	-	200 - 600	200 - 600	200 - 600	200 - 600	200 - 600	750 - 1100 t	-
-	-	-	-	80 - 130	-	-	-	-	-	-	-
-	-	-	-	-							
-	-	-	-	90 - 150	-	-	-	-	-	-	-
-	-	-	-	80 - 140							
-	-	-	-	-	-	-	-	-	-	-	900 - 3000
-	-	-	-	-	-	-	-	-	-	-	900 - 3000
-	-	-	-	-	-	-	-	-	-	-	600 - 2400
-	-	-	-	-	-	-	-	-	-	-	600 - 2000
-	-	-	-	-	-	-	-	-	-	-	300 - 700
-	-	-	-	-	-	-	-	-	-	-	400 - 1300
-	-	-	-	-	-	-	-	-	-	-	400 - 1300
-	-	-	-	-	-	-	-	-	-	-	400 - 1300
-	-	-	-	-	-	-	-	-	-	-	200 - 1000
-	-	-	-	-	-	-	-	-	-	-	200 - 1000
-	-	-	-	-	-	-	-	-	-	-	-
-	-	-	-	-	-	-	-	-	-	-	-
-	-	-	-	-	100 - 140 t	120 - 180 t	120 - 180 t	120 - 180 n	120 - 180 n	-	-
-	-	-	-	-	110 - 240 t	180 - 280 t	180 - 280 t	180 - 230 n	180 - 280 n	-	-

Threaded key adjustment unit for direct installation of inserts

The threaded key adjustment enables the realisation of close stepped tools for finishing operations. A particular advantage is the simple adjustment possibility of the indexable inserts for the adjustment range 0.30 mm in diameter with every design. Depending on the insert position it is possible to carry out an axial as well as a radial adjustment, herewith adjusting the overall length as well as the diameter. Per right hand turn, the

fine adjustment forces the insert into the adjustment direction. Due to the small dimensions it is possible to produce tools from diameter 16.0 mm with insert size 06 (see table). Different basic insert forms can be applied, i.e. triangular, rhombic or square.

No. of edges	from tool Ø		
	index. insert 06	index. insert 09	index. insert 12
1	Ø 16 mm	Ø 29 mm	Ø 36 mm
2	Ø 23 mm	Ø 33 mm	Ø 44 mm
3	Ø 30 mm	Ø 44 mm	Ø 60 mm

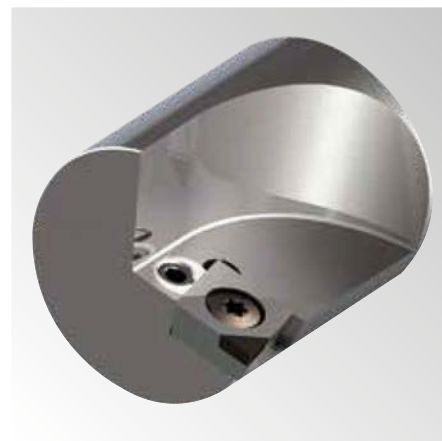
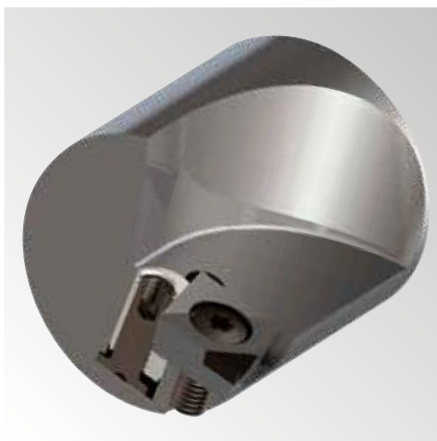

Easy:
The installation and fine adjustment ...

... of a single fluted tool with indexable inserts...

... via threaded key.

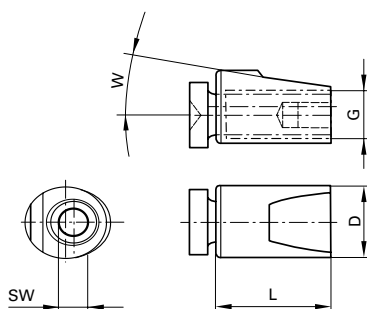

Ordering no. = Guhring no. + Code no.	Size	for indexable inserts	D	G	L	W	SW
4007 4,501	06	CC..06.. / SC..06..	4.5	M 3	5.5	7°	SW 1.5
4007 4,502	06	CP..06.. / SP..06..	4.5	M 3	5.5	11°	SW 1.5
4007 6,001	09	CC..09T3.. / SC..09T3.. / TC..1102..	6.0	M4x0.5	9.3	7°	SW 2.0
4007 6,002	09	CP..09T3.. / SP..09T3.. / TP..1102..	6.0	M4x0.5	9.3	11°	SW 2.0
4007 9,001	12	CC..1204.. / SC..1204.. / TC..16T3..	9.0	M6x0.5	12.7	7°	SW 3.0
4007 9,002	12	CP..1204.. / SP..1204.. / TP..16T3..	9.0	M6x0.5	12.7	11°	SW 3.0
4007 6,003	09	TC..0902..	6.0	M4x0.5	7.7	7°	SW 2.0
4007 6,004	09	TP..0902..	6.0	M4x0.5	5.8	11°	SW 2.0

1. ASSEMBLY

- 1.1 Lightly lubricate the bottom and the walls of the location bore of the TWA as well as the thread of the setting screw with MOS2 assembly paste.
- 1.2 Locate the hexagonal key through the wedge into the setting screw and insert together into the base of the location bore of the adjustment unit (fig.1).
- 1.3 Using the hexagonal key push the setting screw into the radial recess at the base of the bore and screw-in the wedge anticlockwise. When doing this the indexable insert contact surface on the wedge must be positioned towards the indexable insert seat (push the wedge from above onto the setting screw, so that the thread of the wedge can locate onto the setting screw). If when screwing in the wedge the collar of the setting screw “jams” in the location bore (noticeable through the setting screw being difficult to turn), push the entire adjustment unit fully into the location bore with the hexagonal key, if necessary resolve “jam” via clockwise rotation (fig. 2).
- 1.4 Lightly lubricate the indexable insert contact surface on the wedge with MOS2 assembly paste and screw in indexable insert in clockwise direction into the indexable insert seat with indexable insert clamping screw (lightly lubricate thread).
- 1.5 The disassembly is carried out in the reverse order

2. Operation

- 2.1 Using a Torx key lightly tighten the indexable insert clamping screw in a clockwise direction to the smallest diameter setting (wedge and setting screw).
- 2.2 Adjust indexable insert to 0.05 mm of diameter before the final dimension: Insert the hexagonal key in the setting screw and adjust the diameter in clockwise direction (fig. 3). Then tighten the indexable insert clamping screw to the specified tightening torque.
- 2.3 Adjust the indexable insert to the final dimension.
- 2.4 If the diameter has already been exceeded, loosen the adjustment in anti-clockwise direction until the wedge noticeably loosens and re-adjust in clockwise direction. To do this the indexable insert clamping screw does not require loosening.
- 2.5 When replacing the indexable insert or when required lubricate the contact surfaces and the thread of the TWA adjustment unit with MOS2 assembly paste.

3. TIGHTENING TORQUE INDEXABLE INSERT CLAMPING SCREW:



Thread size	Torx size	Tightening torque [Ncm]
M 4 / M4 x 0.5	15	515
3.5	15	345
M 2.5	8	128
M 2.5 / M2.2	7	101

4. KEY SIZES OF THE TWA ADJUSTMENT UNITS AND THE ADJUSTMENT TRAVEL OF THE INDEXABLE INSERTS:

Insert size	Socket	in radius (at ¼ rotation of setting screw)
0602..	SW 1.5	0.015 mm with indexable insert with 7° clearance angle or 0.024 with indexable insert with 11° clearance angle
09T3..	SW 2.5	
1204..	SW 3.0	

Fig. 1: Assembly (s. no. 1.2)

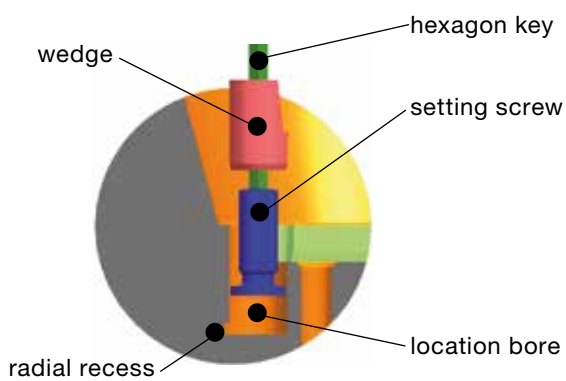

Fig. 2: Assembly (s. no. 1.3)

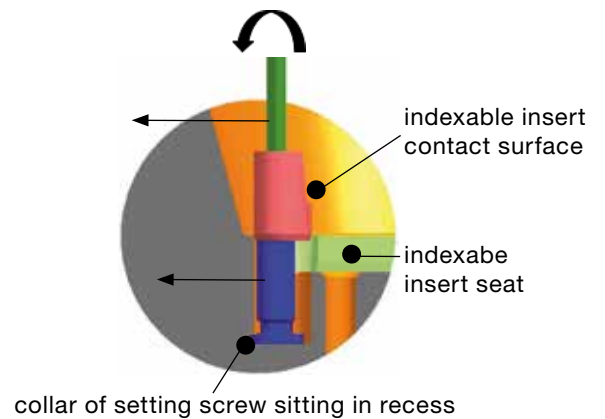

Fig. 3: Operation (s. no. 2.1)

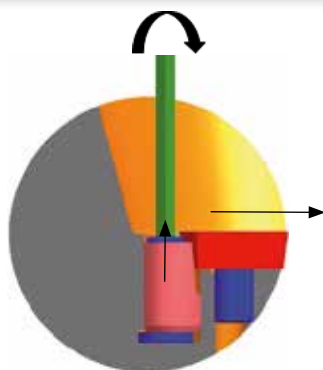
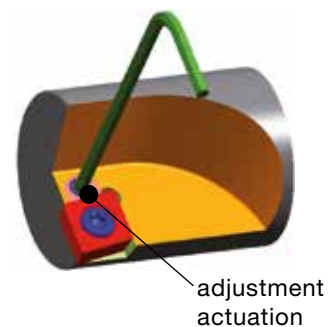

Fig. 4: Operation (s. no. 2.2)



In order to clarify initial queries, we have developed the questionnaire on the following page. Please photocopy and complete. This assist us greatly. ➤

Setting of clamping holder

1. Turn the clamping holder adjustment screw 1 in direction of adjustment until stop.
2. Loosen V-wedge, then pretension again via Bellville spring (do not tighten!).
3. Using hexagonal spanner set adjustment screw 1 (1 mm increments) to the required dimension (1 turn = 2 mm in diameter).
4. Tighten V-wedge.

Setting and changing of center drills

1. Pre-set lengths l1 and l2 according to setting dimensions via setting screw.
2. Place clamping sleeve in the bore of the tool head and finely adjust via tool head adjustment screw 2 which acts axially on chamfer of clamping sleeve.
3. Set clamping sleeve position with clamping screw.
4. Tool change is achieved by loosening clamping screw 2 via hole in the clamping holder without adjusting clamping holder.

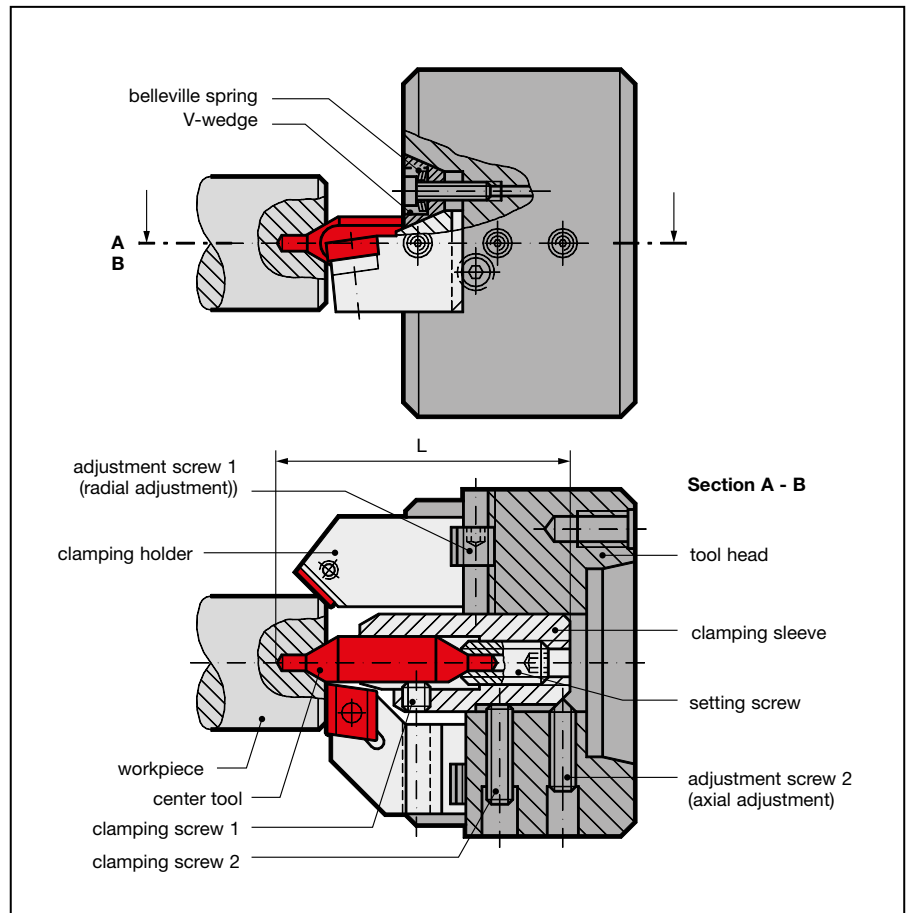

Setting dimensions „L“ for clamping sleeves with center drills or step drills with flats

center drill			Guhring no. 587. 588			Guhring no. 589			Guhring no. 274. 574		
			Center drill with flat for center holes form A or R to DIN 332 sheet 1			Center drill with flat for center holes form B to DIN 332 sheet 1			Center drill with flat for center holes form D or DR to DIN 332 sheet 2		
	Clamping sleeve		Drill-Ø	Dimensions mm		Drill-Ø	Dimensions mm		Drill-Ø	Dimensions mm	
	Guh. no.	Code no.*	mm	L	L1	mm	L	L1	mm	L	L2
	6151	4,000	1.60	47.5	35.5	-	-	-	-	-	-
		5,000	2.00	48.4	40.0	-	-	-	-	-	-
		6,300	2.50	49.5	45.0	-	-	-	-	-	-
		6152	4,000	1.60	62.5	35.5	-	-	-	-	-
	6153	5,000	2.00	63.4	40.0	-	-	-	-	-	-
		6,300	2.50	64.5	45.0	1.60	64.5	45.0	-	-	-
		8,000	3.15	66.0	50.0	2.00	66.0	50.0	M 4	74.7	58.0**
		10,000	4.00	67.9	56.0	2.50	67.9	56.0	M 5	77.8	61.0**
	6154	6,300	2.50	83.0	45.0	1.60	83.0	45.0	-	-	-
		8,000	3.15	87.0	50.0	2.00	87.0	50.0	M 4	95.7	58.0**
		10,000	4.00	88.9	56.0	2.50	88.9	56.0	M 5	98.8	61.0**
		11,200	-	-	-	3.15	87.0	60.0	-	-	-
		12,500	5.00	91.1	63.0	-	-	-	M 6	103.2	71.0
		14,000	-	-	-	4.00	90.1	67.0	M 8	108.3	77.0**
		16,000	6.30	94.0	71.0	-	-	-	M 10	114.1	82.0**
		18,000	-	-	-	5.00	92.7	75.0	-	-	-
	6154	18,000	-	-	-	5.00	148.7	75.0	-	-	-
		20,000	8.00	153.9	80.0	6.30	151.4	80.0	M 12	174.9	105.0
		25,000	10.00	158.5	100.0	8.00	155.4	100.0	M16	186.7	132.0
		31,500	12.50	164.6	125.0	10.00	160.5	125.0	M 20	196.0	145.0

*) When ordering, please always state Guhring no. and code no.!

***) reduced shank length

for the design of end operation tools

www.guehring.de
guehring-ge100@guehring.de

1. Tool

1.1 Technical data

Tool Ø max. _____ mm
 Tool length max. _____ mm
 Tool holder _____
 Suggestion for indexable insert _____

Other machine operation

1.2 Required machining operations

(if possible, please enclose workpiece drawing)

Facing Floating holder

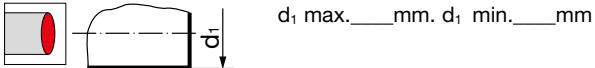

External chamfering Floating holder

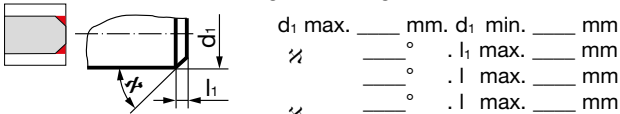

Internal chamfering Floating holder

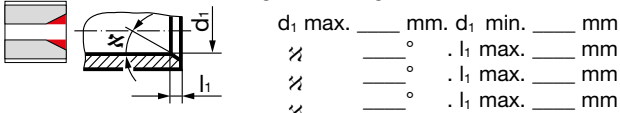

Turning

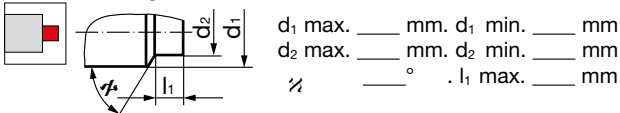

Boring

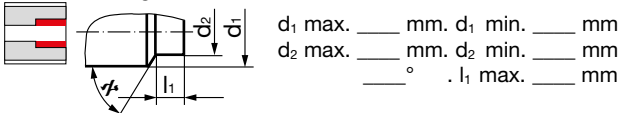

Centering

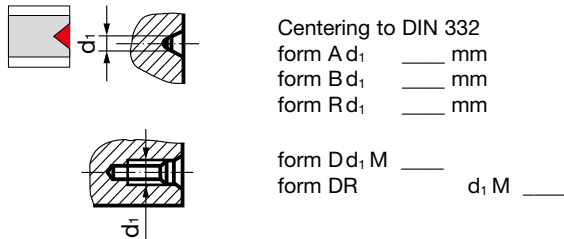

3. Machine

3.1 Technical data

Machine type _____
 Drive power _____ kW
 Coolant
 wet MQL dry

1.3 Quantity required

Basic body _____ short clamping holder _____ pieces

Accessories _____

2. Workpiece

(if possible, please enclose workpiece drawing)

2.1 Material to be machined

Material designation (Mat. no. to DIN)

2.2 Position of workpiece

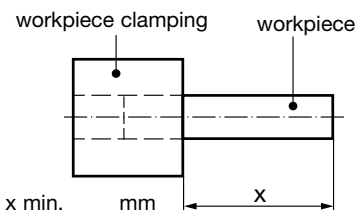

2.3 Other information

(please provide example drawing on reverse side)

Surface finish _____
 Tolerances _____

For technical please contact Mr./Mrs.

Tel.

Company name and address

Date, signature



GUHRING
EFFICIENCY IN PERFECTION

GUHRING

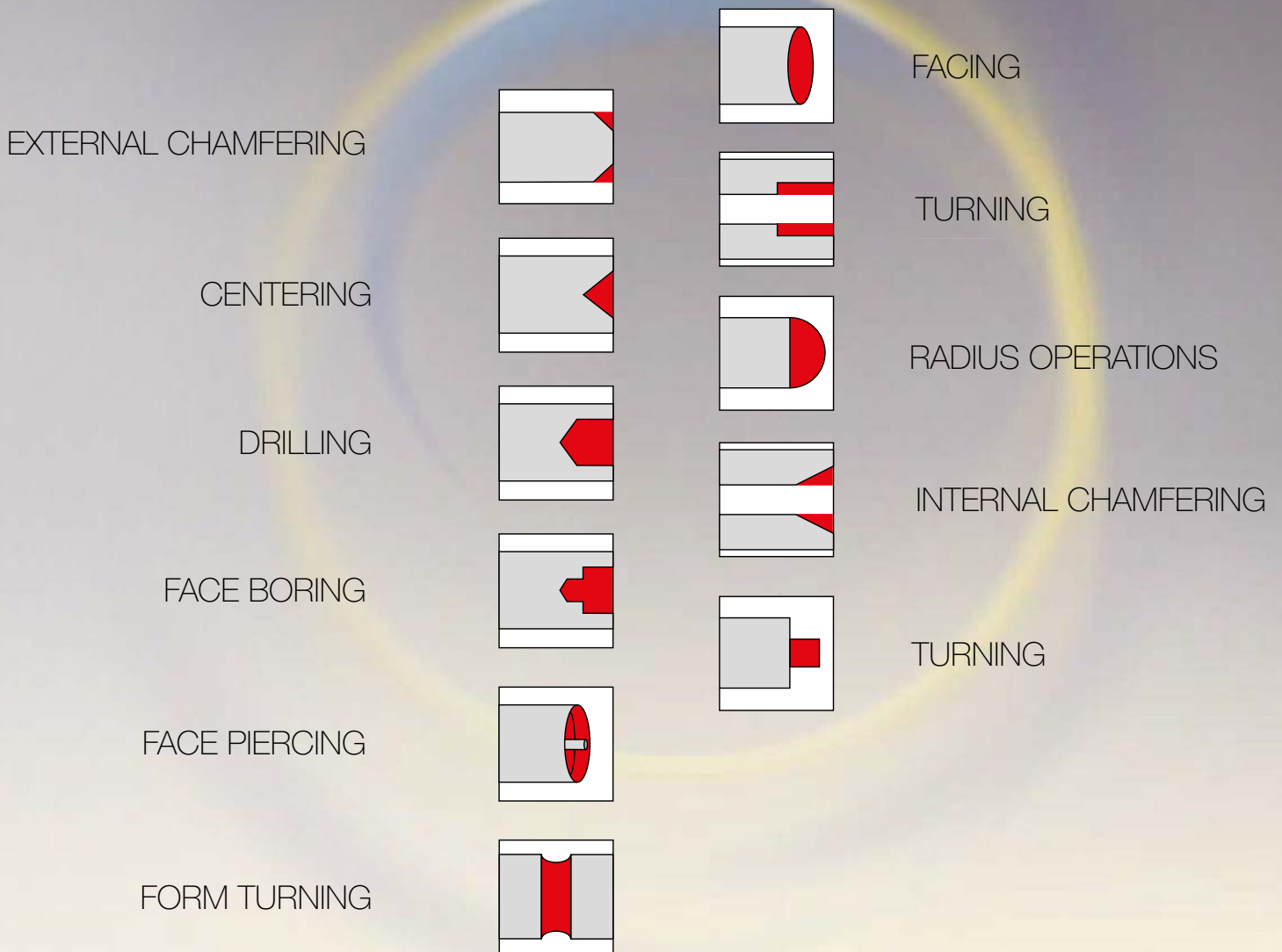

Combine up to 5 Operating Steps
with only one Tool!

GÜHRING KG | Tel.: + 49 74 31 17-0 | Fax: + 49 74 31 17-21279
Herderstrasse 50-54 | 72458 Albstadt | Germany | info@guehring.de | www.guehring.com